

**OPERATING,  
MAINTENANCE &  
PARTS MANUAL**

---

**MANUALLY LEVER  
OPERATED  
CHAIN HOIST**

# **CM<sup>®</sup> Puller**

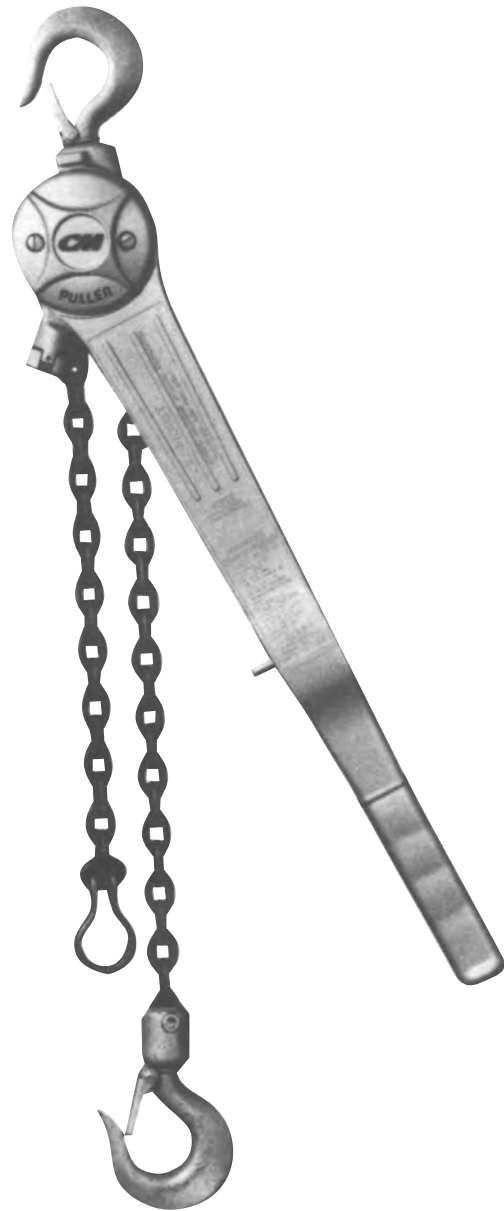

Before installing hoist, fill in the information below.

Model No. \_\_\_\_\_

Serial No. \_\_\_\_\_

Purchase Date \_\_\_\_\_

Rated Load \_\_\_\_\_

**Capacities: 3/4, 1-1/2, 3 and 6 tons (750, 1500, 3000 and 6000 kg.)**

**Follow all instructions and warnings for inspecting, maintaining and operating this hoist.**

The use of any hoist presents some risk of personal injury or property damage. That risk is greatly increased if proper instructions and warnings are not followed. Before using this hoist, each operator should become thoroughly familiar with all warnings, instructions and recommendations in this manual. **Retain this manual for future reference and use.**

Forward this manual to operator. Failure to operate equipment as directed in manual may cause injury.

**CM HOIST PARTS AND SERVICE ARE AVAILABLE IN THE UNITED STATES AND IN CANADA**

As a CM Hoist user, you are assured of reliable repair and parts services through a network of Master Parts Depots and Service Centers that are strategically located in the United States and Canada. These facilities have been selected on the basis of their demonstrated ability to handle all parts and repair requirements promptly and efficiently.

Below is a list of the Master Parts Depots in the United States and Canada. To quickly obtain the name of the U.S. Service Center located nearest you, call (800) 888-0985. Fax: (716) 689-5644. In the following list, the Canadian Service Centers are indicated.

**UNITED STATES MASTER PARTS DEPOT****CALIFORNIA**

OTTO SYSTEMS, INC.  
12010 Bloomfield Ave.  
Sante Fe Springs, CA 90670  
562/462-1612 or 800/596-7392  
Fax 562/462-1617  
or  
7656 Las Positas Road  
Livermore, CA 94551  
925/245-8800 or 800/508-6886  
Fax 925/245-8804

**GEORGIA**

ACE INDUSTRIES, INC.  
6295 McDonough Drive  
Norcross, GA 30093  
770/441-0898 or 800/733-2231  
Fax 800/628-3648

**ILLINOIS**

JOHN SAKASH COMPANY, INC.  
700Walnut Street  
Elmhurst, IL 60126  
630/833-3940  
Fax 630/833-9830

**INDIANA**

HORNER ELECTRIC COMPANY, INC.  
1521 East Washington Street  
Indianapolis, IN 46201  
317/639-4261  
Fax 317/639-4342

**IOWA**

VM HOIST & CRANE SERVICES  
PO Box 440  
450 Highway 151  
Walford, IA 52351  
319/846-6040  
Fax 319/846-6045

**KANSAS**

INDEPENDENT ELECTRIC MACHINERY  
4425 Oliver Street  
Kansas City, KS 66106  
913/362-1155 or 800/833-2610  
Fax 913/904-3330

**LOUISIANA**

BEERMAN PRECISION, INC.  
PO Box 6018  
Metairie, LA 70009  
504/207-6000  
Fax 504/207-6044

**MASSACHUSETTS**

ABEL DISTRIBUTORS, INC.  
50 Parker Street, Unit 2  
Newburyport, MA 01950  
978/463-0700  
Fax 978/463-5200

**NEW JERSEY**

SHUPPER-BRICKLE EQUIPMENT CO.  
PO Box 803  
2394 Route 130, Suite C  
Dayton, NJ 08810  
732/438-3888  
Fax 732/438-3889

**NEW YORK**

VOLLAND ELECTRIC EQUIPMENT CO.  
75 Innsbruck Drive  
Buffalo, NY 14227  
716/656-9900  
Fax 716/656-8899

**NORTH CAROLINA**

TEAM SESCO  
2225 Freedom Drive  
Charlotte, NC 28208  
704/372-4832 or 800/487-3726  
Fax 704/358-1098

**OHIO**

MAZZELLA LIFTING TECHNOLOGIES  
21000 Aerospace Parkway  
Cleveland, OH 44142  
440/239-5700 or 800/362-4601  
Fax 440/239-5707

**PENNSYLVANIA**

AMICK ASSOCIATES, INC.  
11 Sycamore Street  
PO Box 529  
Carnegie, PA 15106-0529  
412/429-1212 or 800/445-9456  
Fax 412/429-0191

RAM MOTORS & CONTROLS, INC.  
5460-B Pottsville Pike, Docks 8-11  
PO Box 748  
Leesport, PA 19533  
610/916-8000  
Fax 610/916-7957

**SOUTH CAROLINA**

ENGINEERED SYSTEMS, INC.  
1121 Duncan-Reidville Road  
Duncan, SC 29334  
864/879-7438 or 800/879-7438

**TEXAS**

ABEL EQUIPMENT CO., INC.  
3710 Cavalier Drive  
Garland, TX 75042  
972/272-7706  
Fax 972/272-6955

**HYDRAULIC EQUIPMENT SERVICES, INC.**

1021 North San Jacinto Street  
Houston, TX 77002  
713/228-9601  
Fax 713/228-0931

**WISCONSIN**

TRESTER HOIST & EQUIPMENT, INC.  
W136 N4863 Campbell Drive  
Suite #4  
Menomonee Falls, WI 53051  
262/790-0700 or 800/234-6098  
Fax 262/790-1009

**CANADIAN SERVICE CENTERS****ALBERTA**

BENNETT & EMMOTT, LTD.  
18131 118th Avenue  
Edmonton, Alberta T5S 1M8  
403/454-9000  
Fax 403/454-8990

**\*\*COLUMBUS McKINNON, LTD.**

10311-174th Street  
Edmonton, Alberta T5S 1H1  
800/263-1997  
Fax 403/486-6160

**BRITISH COLUMBIA**

FLECK BROTHERS, LTD.  
4084 McConnel Court  
Burnaby, British Columbia V5A 3N7

**MANITOBA**

KING'S ELECTRIC MOTORS, INC.  
633 Tyne Avenue  
Winnipeg, Manitoba R2L 1J5  
204/663-5332  
Fax 204/663-4059

**NOVA SCOTIA**

\*W & A MOIR  
95 Ilsley Ave.  
Burnside Park, Nova Scotia B3B 1L5  
902/468-7720  
Fax 902/468-3777

**ONTARIO**

\*R & W HOIST REPAIR, LTD.  
790 Redwood Square  
Units 5, 6, & 7  
Oakville, Ontario L6L 6N3  
905/825-5500  
Fax 905/825-5315

**\*TORONTO ELECTRIC HOIST**

SALES & SERVICE  
9 CoDeco Court  
North York, Ontario M3A 1A1  
416/386-0820  
Fax 416/386-0821

**\*MASLACK SUPPLY, LTD.**

488 Falconbridge Road  
Sudbury, Ontario P3A 4S4  
705/566-1270  
Fax 705/566-4208

**\*COLUMBUS McKINNON, LTD.**

P.O. Box 1106  
10 Brook Road, North  
Cobourg, Ontario K9A 4W5  
905/372-0153  
Fax 905/372-3078

**QUEBEC**

\*HERCULES SLING & CABLE  
3800 TransCanada Highway  
Pointe-Claire, Quebec H9R 1B1  
514/428-5511  
Fax 514/428-5555

**\*LEGER PALANS ET OUTILLAGES, INC.**

7995-17th Ave.  
Montreal, Quebec H1Z 3R2  
514/376-3050  
Fax 514/376-0657

\*ARE ALSO MASTER PARTS DEPOTS

\*\*MASTER PARTS DEPOT ONLY

## SAFETY PRECAUTIONS

Each CM® Puller Manually Operated Chain Hoist is built in accordance with the specifications contained herein and at the time of manufacture complies with our interpretation of applicable sections of \*ASME B30.21, \*ANSI/ASME HST-3M and the Occupational Safety and Health Act-1970.

The safety laws for elevators and for dumbwaiters specify construction details that are not incorporated in CM® industrial hoists. We recommend the use of equipment that meets state and national safety codes for such use. Columbus McKinnon Corporation cannot be responsible for applications other than those for which CM® equipment is recommended.



THIS SYMBOL POINTS OUT IMPORTANT SAFETY INSTRUCTIONS WHICH IF NOT FOLLOWED COULD ENDANGER THE PERSONAL SAFETY AND/OR PROPERTY OF YOURSELF AND OTHERS. READ AND FOLLOW ALL INSTRUCTIONS IN THIS MANUAL AND ANY PROVIDED WITH THE EQUIPMENT BEFORE ATTEMPTING TO OPERATE YOUR PULLER.



\*Copies of these standards may be obtained from ASME Order Department, 22 Law Drive, Box 2300, Fairfield, NJ 07007-2300.

### **WARNING!**

Improper operation of a hoist can create a potentially hazardous situation which, if not avoided, could result in death or serious injury. To avoid such a potentially hazardous situation, the operator shall:

1. NOT operate a malfunctioning or unusually performing hoist.
2. NOT operate the hoist until you have thoroughly read and understood this Operating, Maintenance and Parts Manual.
3. NOT operate a hoist which has been modified without the manufacturer's approval or certification to be in conformity with applicable OSHA regulations.
4. NOT lift or pull more than rated load for the hoist.
5. NOT use damaged hoist or hoist that is Not working properly.
6. NOT use hoist with twisted, kinked, damaged, or worn load chain.
7. NOT operate with any lever extension (cheater bar).
8. NOT attempt to "free-chain" the hoist while a load is applied.
9. NOT use the hoist to lift, support, or transport people.
10. NOT lift loads over people and make sure all personnel remain clear of the supported load.
11. NOT attempt to lengthen the load chain or repair damaged load chain.
12. Protect the hoist's load chain from weld splatter or other damaging contaminants.
13. NOT operate hoist when it is restricted from forming a straight line from hook to hook in the direction of loading.
14. NOT use load chain as a sling or wrap load chain around load.
15. NOT apply the load to the tip of the hook or to the hook latch.
16. NOT apply load unless load chain is properly seated in the chain wheel(s) or sprocket(s).
17. NOT apply load if bearing prevents equal loading on all load supporting chains.
18. NOT operate beyond the limits of the load chain travel.
19. NOT leave load supported by the hoist unattended unless specific precautions have been taken.
20. NOT allow the chain or hook to be used as an electrical or welding ground.
21. NOT allow the chain or hook to be touched by a live welding electrode.
22. NOT remove or obscure the warnings on the hoist.
23. NOT operate a hoist which has Not been securely attached to a suitable support.
24. NOT operate a hoist unless load slings or other approved single attachments are properly sized and seated in the hook saddle.

25. NOT lift loads that are Not balanced and that the holding action is Not secure, taking up slack carefully.
26. NOT operate a hoist unless all persons are and remain clear of the supported load.
27. Report malfunctions or unusual performances of a hoist, after it has been shut down until repaired.
28. NOT operate a hoist on which the safety placards or decals are missing or illegible.
29. Be familiar with operating controls, procedures, and warnings.

### **CAUTION!**

Improper operation of a hoist can create a potentially hazardous situation which, if not avoided, could result in minor or moderate injury. To avoid such a potentially hazardous situation, the operator shall:

1. Maintain a firm footing or be otherwise secured when operating the hoist.
2. Check brake function by tensioning the hoist prior to each lift or pulling function.
3. Use hook latches. Latches are to retain slings, chains, etc. under slack conditions only.
4. Make sure the hook latches are closed and not supporting any parts of the load.
5. Make sure the load is free to move and will clear all obstructions.
6. Avoid swinging the load or hook.
7. Avoid lever "fly-back" by keeping a firm grip on the lever until operating stroke is completed and the lever is at rest.
8. Inspect the hoist regularly, replace damaged or worn parts, and keep appropriate records of maintenance.
9. Use the hoist manufacturer's recommended parts when repairing the unit.
10. Lubricate load chain per hoist manufacturer's recommendations.
11. NOT use the hoist load limiting or warning device to measure load.
12. NOT operate except with manual power.
13. NOT permit more than one operator to pull on lever at the same time. More than one operator is likely to cause hoist overload.
14. NOT allow your attention to be diverted from operating the hoist.
15. NOT allow the hoist to be subjected to sharp contact with other hoists, structures, or objects through misuse.
16. NOT adjust or repair the hoist unless qualified to perform such adjustments or repairs.

# Hoist Safety is up to you...

**⚠ WARNING - DO NOT APPLY MORE THAN RATED LOAD.**

## 1 CHOOSE THE RIGHT HOIST FOR THE JOB...

Choose a Puller with the capacity for the job. Know the capacities of your hoists and the weight of your loads. Then match them.

The application, the size and type of load, the attachments to be used and the period of use must also be taken into consideration in selecting the right hoist for the job.



Remember the Short Handle Puller was designed to ease our burden and carelessness not only endangers the operator, but in many cases, a valuable load.

**⚠ WARNING - DO NOT OPERATE DAMAGED OR MALFUNCTIONING UNIT. - DO NOT OPERATE WITH TWISTED, KINKED OR DAMAGED CHAIN.**

## 2 INSPECT

All Short Handle Pullers should be visually inspected before use, in addition to regular, periodic maintenance inspections.

Inspect hoists for operations warning notices and legibility.

Deficiencies should be noted and brought to the attention of supervisors. Be sure defective Pullers are tagged and taken out of service until repairs are made.



Under no circumstances should you operate a malfunctioning hoist.

Check for gouged, twisted, distorted links and foreign material. Do not operate Pullers with twisted, kinked or damaged chain links.

Load chain should be properly lubricated.

Hooks that are bent, worn or whose openings are enlarged beyond normal throat opening should not be used. If latch does not engage throat opening of hook, hoist should be taken out of service.

Chains should be checked for deposits of foreign material which may be carried into the hoist mechanism.

Check brake for evidence of slippage under load

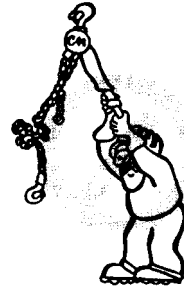

**⚠ WARNING - DO NOT PULL AT AN ANGLE. BE SURE HOIST AND LOAD ARE IN A STRAIGHT LINE. - DO NOT USE UNLESS FRAME AND CHAIN FORM A STRAIGHT LINE BETWEEN HOOKS. - DO NOT USE IF FRAME IS IN CONTACT WITH ANY OBJECT. - DO NOT USE LOAD CHAIN AS A SLING. - DO NOT USE AN EXTENSION ON THE LEVER.**

## 3 USE HOIST PROPERLY



Be sure the Puller is solidly held in the uppermost part of the support hook arc.



Be sure the Short Handle Puller and load are in a straight line. Do not use unless frame and chain form a straight line between hooks.

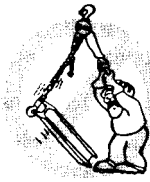

Be sure load is hooked securely. Do not tip load the hook. Do not load hook latch. Hook latch is to prevent detachment of load under slack chain conditions only.

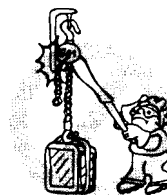

Do not operate with Puller frame resting against any object. Apply the load gently. Do not jerk it.



Never use an extension on the lever! You're dangerously overloading the Puller if you exceed the rated lever pull or if you have to use a lever extension to lift or pull a load.

**⚠ WARNING - DO NOT LIFT PEOPLE OR LOADS OVER PEOPLE.**

## 4 PRACTICE CAUTION ALWAYS

Do not lift co-workers with a Short Handle Puller.

Make sure everyone is clear of the load when you apply tension.

Do not remove or obscure operational warning notices.

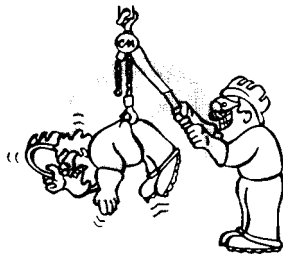

## 5 OPERATOR SERVICE

**CLEANING**  
Short Handle Pullers should be kept clean and free of dust, dirt, moisture, etc., which will in any way affect the operation or safety of the equipment.

**LUBRICATION**  
Chain should be properly lubricated.

**AFTER REPAIRS**  
Carefully operate the hoist before returning it to full service.



iii

**VIOLATION OF ANY OF THE WARNINGS LISTED MAY RESULT IN SERIOUS PERSONAL INJURY TO THE OPERATOR OR NEARBY PERSONNEL BY RELEASED LOAD OR BROKEN HOIST COMPONENTS.**

# FOREWORD

This manual contains important information to help you properly install, operate and maintain your Puller for maximum performance, economy and safety.

Please study its contents thoroughly before putting your Puller into operation. By practicing correct operating procedures and by carrying out the recommended preventive maintenance suggestions, you will be assured of long, dependable and safe service.

After you have completely familiarized yourself with the contents of this manual, we recommend that you carefully file it for future reference.

The information herein is directed to the proper use, care and maintenance of the Puller and does not comprise a handbook on the broad subject of rigging.

Rigging can be defined as the process of lifting and moving heavy loads using hoists and other mechanical equipment. Skill acquired through specialized experience and study is essential to safe rigging operations. For rigging information, we recommend consulting a standard textbook on the subject.

A copy of this manual is packed with each Puller.

## TABLE OF CONTENTS

Master Parts Depots and Service Centers.....	i
Do's and Do Not's.....	ii
Hoist Safety Is Up To You.....	iii
Foreword.....	1
Specifications.....	2
CM Repairs/Replacement Policy.....	2
Load Limiter.....	2
Anchor Sling.....	2
Hooks.....	2
Load Sentry.....	3
<b>INSTALLATION AND OPERATION</b>	
Unpacking Information.....	3
Installation.....	3
Operating Instructions.....	4
<b>INSPECTION</b> .....	5
Frequent Inspections.....	5
Periodic Inspections.....	5
Hook Inspection.....	6
Chain Inspection.....	6
Chain Lubrication.....	7
<b>MAINTENANCE</b>	
Lubrication.....	7
Exterior Finish.....	7
Preventive Maintenance.....	7
Recommended Spare Parts.....	8
Disassembly.....	8
Assembly.....	8
Reeving.....	9
Cutting Chains.....	15
Testing.....	15
Trouble Shooting.....	16
<b>LOAD LIMITER</b> .....	17
<b>REPAIR PARTS</b>	
Ordering Information.....	11
Parts List.....	11-12
Exploded Views.....	13-14

## LIST OF ILLUSTRATIONS

	PAGE
Figure 1 Pulling on an Angle.....	3
Figure 2 Horizontal Pulling.....	3
Figure 3 Vertical Lifting.....	3
Figure 4 Angle Pulling.....	4
Figure 5 Latch Hook Opening.....	6
Figure 6 Latchlok Hook Opening.....	6
Figure 7 Gaging Load Chain Wear.....	7
Figure 8 Ratchet & Ratchet Plunger Assembly.....	8
Figure 9 Brake Parts.....	8
Figure 10 Brake Nut Cotter Pin Assembly.....	8
Figure 11 Lever Assembly.....	9
Figure 12 Chain Assembly - Hook End, 3/4 Ton.....	9
Figure 13 Chain Assembly - Hook End, 1-1/2 Ton.....	9
Figure 14 Reeving 3-Ton.....	10
Figure 15 Reeving 6-Ton.....	10
Figure 16 Exploded View 3/4-6 Ton Puller.....	13-14
Figure 17 Cutting Chain By Nicking.....	15
Figure 18 Cutting Chain With a Bolt Cutter.....	15
Figure 19 Load Limiter.....	17

# GENERAL INFORMATION

## SPECIFICATIONS

CM<sup>®</sup> Puller Manually Operated Chain Hoist is a highly versatile tool that can be used to efficiently pull, lift, drag, or stretch. The load chain is strong and durable CM<sup>®</sup> Hoistaloy<sup>®</sup>. The frame and lever are made of lightweight aluminum alloy. An automatic brake supplies positive load control and will suspend the load at any point. Latch type hooks are standard on all capacities. The pullers have lever lengths of 23 inches (584 mm).

The standard lift on all Pullers is 5 feet (1.5 mm). However, pullers with longer lift can be supplied on a special, per order basis.

CM<sup>®</sup>'s Load Limiter and Load Sentry are optional items for Pullers with standard levers. The optional CM<sup>®</sup> Anchor Sling is available for the 3/4 and 1-1/2 ton Pullers with standard or short lever. CM<sup>®</sup>'s Latchlok upper and lower hooks are optional items for all Pullers.

Code	DC Code	Capacity (Tons)	Pull On Lever To Lift Full Load Lbs(kg)	Net Weight Lbs(kg)	Minimum Distance Between Hooks In.(mm)
4043	64043	3/4	58 (26)	14 (6.4)	10-3/4(273)
4045	64045	1-1/2	83 (38)	24 (10.8)	14-1/4(362)
4047	64047	3	95 (43)	35 (15.6)	17(432)
4050	64050	6	96 (44)	70 (31.8)	21-3/8(543)
4190	64190	3/4	Load Limiter Kit (Standard Lever Only)		
4191	64191	1-1/2-6	Load Limiter Kit (Standard Lever Only)		
4071	64071	3/4	Anchor Sling Kit		
4072	64072	1-1/2	Anchor Sling Kit		
4096	64096	3/4	Load Sentry Kit (Standard Lever Only)		
4098	64098	1-1/2-6	Load Sentry Kit (Standard Lever Only)		

## CM<sup>®</sup> REPAIR/REPLACEMENT POLICY

All Columbus McKinnon (CM<sup>®</sup>) Pullers are thoroughly inspected and performance tested prior to shipment. If any properly maintained Puller develops a performance problem due to a material or workmanship defect, as verified by CM<sup>®</sup>, repair or replacement of the unit will be made to the original purchaser without charge. This repair/replacement policy applies only to Pullers installed, maintained and operated as outlined in this manual, and specifically excludes parts subject to normal wear, abuse, improper installation, improper or inadequate maintenance, hostile environment effects, and unauthorized repairs/modifications.

We reserve the right to change materials or design if, in our opinion, such changes will improve our product. Abuse, repair by an unauthorized person, or use of non CM<sup>®</sup> replacement parts voids the guarantee and could lead to dangerous operation. For full Terms of Sale, see Sales Order Acknowledgment. Also, refer to the back cover for Limitations of Warranties, Remedies and Damages and, Indemnification's and Safe Operation.



## OPTIONAL LOAD LIMITER

### LOAD LIMITER<sup>®</sup>

The Load Limiter is a friction device that is designed and factory calibrated to prevent the lifting of excessive overloads with 3/4, 1-1/2, 3 and 6 Ton Pullers that have standard levers. Excessive overload is indicated by lever movement without the corresponding movement of the lower hook block or load when the unit is operated in the "Up" direction. Should overload be evident, immediately switch the trigger to "Down" direction and operate the lever to remove the excess load from the unit. The reduction of the load to rated capacity or less will result in automatic restoration of normal operation.

Load Limiter assures positive warning of overload condition. You may order the Load Limiter as part of your new Puller or in kit form for easy installation in units with standard levers now in use. The Load Limiter is designed for use on the CM<sup>®</sup> Puller only. For additional information on the Load Limiter refer to page 17.

## ANCHOR SLING (3/4 and 1-1/2 Ton Units)

Anchor Sling is an upper hook extender that simplifies attachment when application or space limitation makes it impossible to pull in a straight line from hook to hook. A swiveling hook block is securely anchored to the tool housing and the upper hook swivels through a full 360. Anchor Sling may be ordered as a feature of your new CM<sup>®</sup> Puller or in kit form for simple installation on units now in use.

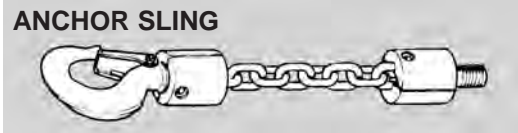

### HOOKS

Type of hooks supplied on the CM<sup>®</sup> Puller.

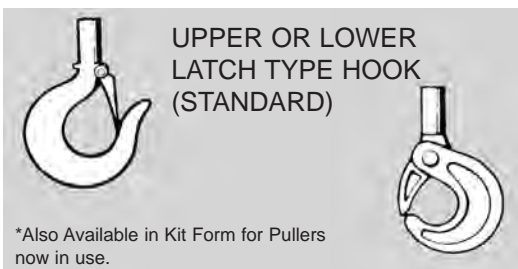

\*Also Available in Kit Form for Pullers now in use.

### LOAD SENTRY (3/4 thru 6 Ton Units with Standard Levers)

The Load Sentry is an overload indicating device. When dangerous overloads, in excess of rated capacity, are applied to the unit, the Load Sentry grip gradually deflects with increasing overloads to warn of the danger involved.

 <b>WARNING</b>
<b>GRIP DEFLECTION DENOTES DANGEROUS OVERLOADING.</b>
<b>TO AVOID INJURY: DO NOT CONTINUE OPERATION AT LEVER FORCES WHICH CAUSE GRIP DEFLECTION.</b>

Since calibration is permanent and is pre-set by the factory, the user should not tamper with the calibration nor should repair be made by the user.

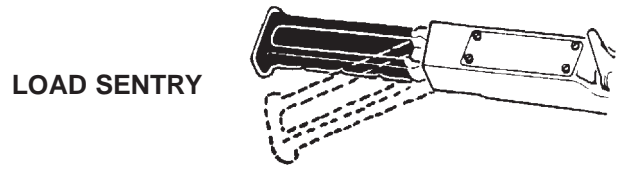

Load Sentry assures positive warning of overload condition. You may order Load Sentry as part of your new Puller or in kit form for easy installation in units now in use. The CM® Load Sentry is designed for use on the CM® Puller only.

## INSTALLATION AND OPERATION

### UNPACKING INFORMATION

After removing the Puller from the carton, check to be sure there has been no damage in shipment. If shipping damage has occurred, refer to the packing list envelope on the carton for claim procedure. Before cutting the chain ties on multiple-reeved units, be sure that all strands of chain are straight with no twist (due to a capsized hook block). If length of lift is to be modified, follow disassembly and assembly instructions for correct procedure. Make certain that the hook side of the chain is on the side of the tool marked "lower hook side" on the chain guide.

 <b>WARNING</b>
<b>IF THE UNIT IS NOT RIGGED IN A STRAIGHT LINE HOOK TO HOOK MANNER, AND IF THE FRAME IS NOT FREE TO SWIVEL, LEVER PULL MAY BREAK FRAME AND CAUSE PHYSICAL INJURY AND LOSS OF LOAD.</b>
<b>TO AVOID INJURY: RIG THE UNIT IN A STRAIGHT LINE HOOK TO HOOK MANNER AND KEEP FRAME FREE TO SWIVEL - SEE FIGURE 4.</b>

### INSTALLATION

The Puller can be used in any position provided it is rigged to pull in a straight line from hook to hook.

Figures 1 through 3 show proper operation for common applications. It is important that the frame is free to swivel on the upper hook. Under no condition should the frame be allowed to touch the load or bear on any support when in use as this might cause bending of the hook or frame and possible failure. When operating in limited areas it is recommended that lifting attachments or slings be used to keep the frame and lever from being obstructed.



**Figure 2. Horizontal Pulling**



**Figure 1. Pulling on an Angle**



**Figure 3. Vertical Pulling**

# OPERATING INSTRUCTIONS

<b>! WARNING</b>
IF NOT USED AS DIRECTED, PULLER MAY CAUSE INJURY.
<b>TO AVOID INJURY:</b>
USE ONLY AS DIRECTED BELOW.

**Free Wheeling** - In this mode brake and lever are disengaged to allow chain to be pulled through the Puller by hand, for quick and easy attachment to the load.

<b>! WARNING</b>
PULLING OUT OR TURNING THE RATCHET PLUNGER WITH A LOAD ATTACHED WILL ALLOW THE LOAD TO RELEASE AND MAY CAUSE INJURY.
<b>TO AVOID INJURY:</b>
NEVER PULL OR TURN RATCHET PLUNGER WHEN THE PULLER IS UNDER LOAD.

To put Puller in free wheeling:

- (1) Be sure unit is **not** loaded.
- (2) Pull out ratchet plunger.
- (3) Turn ratchet plunger 1/4 turn left or right.
- (4) Turn the lever trigger 1/4 turn from "UP" or "DOWN".

Grasp the Puller by the frame or upper hook and pull on the end ring or lower hook to pull the chain through the unit. **DO NOT** hold the lever when free chaining as this may cause the chain to jam in the unit.

After attaching to the load, turn ratchet plunger 1/4 turn until it snaps into engagement and turn lever trigger to "UP" or "DOWN" for further use.

<b>! WARNING</b>
IF THE UNIT IS NOT RIGGED IN A STRAIGHT LINE HOOK TO HOOK MANNER, AND IF THE FRAME IS NOT FREE TO SWIVEL, LEVER PULL MAY BREAK FRAME AND CAUSE PHYSICAL INJURY AND LOSS OF LOAD.
<b>TO AVOID INJURY:</b>
RIG THE UNIT IN A STRAIGHT LINE HOOK TO HOOK MANNER AND KEEP FRAME FREE TO SWIVEL - SEE FIGURE 4.

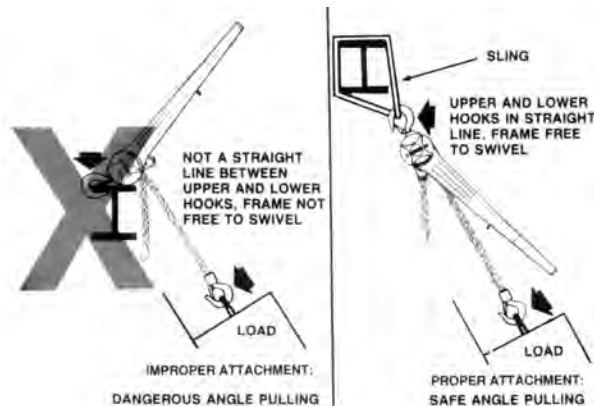

Figure 4. Angle Pulling

**Attaching Load** - As discussed in installation section, attach load so that upper and lower hooks are in a straight line with the frame free to swivel on upper hook. If proposed use prevents straight line attachment, use an Anchor Sling (see page 2) or chain sling to obtain a straight line pull. Refer to Figure 4.

**To Pull or Lift Load** - Put lever trigger in "UP" position. Lever pull in "UP" position shortens distance

<b>! WARNING</b>
MALFUNCTION OF UNIT, RIGGING SLIP OR LOSS OF FOOTING MAY CAUSE USER TO SLIP RESULTING IN INJURY.
<b>TO AVOID INJURY:</b>
ALWAYS HAVE A FIRM AND SECURE FOOTING WHEN USING THE CM PULLER.

between hooks. Observe that ratchet plunger is not changed when changing from "UP" to "DOWN" or "DOWN" to "UP" positions.

**To Loosen or Lower Load** - Put lever trigger in "DOWN" position. Lever pull in "DOWN" position increases distance between hooks.

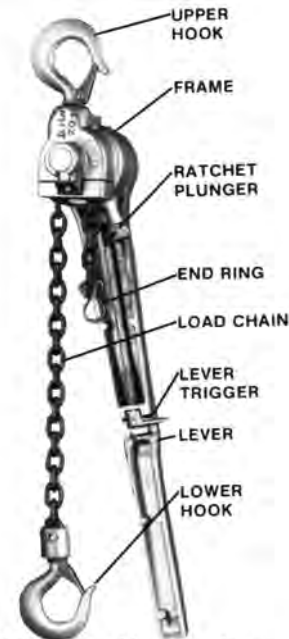

CM Puller Nomenclature

<b>! WARNING-TO AVOID INJURY:</b>
Use as directed above. Failure to do so may cause injury to you or others.
<ol style="list-style-type: none"> <li>1. Do not exceed capacity shown on frame or lower hook block.</li> <li>2. Do not use to lift people or loads over people.</li> <li>3. Do not use unless the Puller's frame and chain form a straight line between hooks.</li> <li>4. Do not use if the frame is in contact with any object.</li> <li>5. Do not use if the unit is damaged or malfunctions.</li> <li>6. Do not use extension on lever. Use hand power only.</li> <li>7. Do not use if chain is twisted, kinked or damaged.</li> </ol>



**NOTE: Refer to page 17 for information pertaining to the operation of Pullers equipped with the Load Limiter®**

**Inspect Puller** before each use and at specified intervals as directed in inspection section.

1. When preparing to lift or move a load be sure that the attachments both hooks are firmly seated in the saddles of the hooks. Avoid off-center loading of any kind especially loading on the point of the hook. Do not load the hook latch as it is to retain slack chain as an aid in hook-up only.

 <b>WARNING</b>
ALLOWING THE LOAD TO BEAR AGAINST THE HOOK LATCH AND/OR HOOK TIP CAN RESULT IN LOSS OF LOAD.
<p style="text-align: center;"><b>TO AVOID INJURY:</b></p> DO NOT ALLOW THE LOAD TO BEAR AGAINST THE HOOK LATCH AND/OR HOOK TIP. APPLY LOAD TO HOOK BOWL OR SADDLE ONLY.

2. When lifting or pulling, raise or move the load only enough to clear the floor or support. Check to be sure brake will hold load and that attachments to hooks and load are firmly seated. Continue the lift only after you are assured the load is free of all obstructions.
3. Do not load beyond the rated capacity. Overload can cause immediate failure of some load carrying part of create a defect causing future failure at less than rated capacity. When in doubt, use the next larger capacity of CM® Puller.
4. As shown in the lever pull table approximately 100 pounds (44kg.) maximum is required to pull rated load. Operate by hand only and do not use an extension on

<b>Lever Pull To Lift Rated Load</b>	
Capacity (Tons)	Lever Pull Lbs/ (kg.)
3/4	58 (26)
1-1/2	83 (38)
3	95 (43)
6	96 (44)

- lever. A need for an extension is an indication of either an overload or an incorrectly maintained unit. Use a Puller of adequate capacity which is in good operating condition.
5. Under no condition should any attempt be made to pry the ratchet plunger out of engagement when a load is on the unit, as this allows the load to fall.

 <b>WARNING</b>
PULLING OUT OR TURNING THE RATCHET PLUNGER WITH A LOAD ATTACHED WILL ALLOW THE LOAD TO RELEASE AND MAY CAUSE INJURY.
<p style="text-align: center;"><b>TO AVOID INJURY:</b></p> DO NOT PRY THE RACHET PLUNGER OUT OF ENGAGEMENT WHEN A LOAD IS ON THE PULLER.

6. Do not use this or any other overhead materials handling equipment for lifting persons.
7. Stand clear of all loads and avoid moving a load over the heads of other personnel. Warn personnel of your intention to move a load in their area.
8. Do not leave the load applied in an unattended manner.
9. Do not lower load chain to the point where the end ring becomes jammed against frame. (See Trouble Shooting chart on page 16).
10. The CM® Puller has been designed for hand powered operation only.
11. Do not wrap the load chain around the load and hook onto itself as a choker chain.
12. Do not wrap load chain around the load or bring the load in contact with the Puller. Doing this will result in the loss of the swivel effect of the hook which could mean twisted chain and a jammed liftwheel. The chain could be damaged at the hook.
13. Do not operate the hoist unless it is rigged to pull in a straight line from hook to hook, and the frame is free to swivel on the upper hook. Refer to Figure 4.
14. Never operate the hoist when flammable materials or vapors are present. Contact between metal parts may produce sparks that can cause a fire or explosion.
15. **STAY ALERT!** Watch what you are doing and use common sense. Do not use the hoist when you are tired, distracted or under the influence of drugs, alcohol or medication causing diminished control.

## INSPECTION

To maintain continuous and satisfactory operation, a regular periodic inspection procedure must be initiated so that worn, damaged and missing parts can be replaced before the unit becomes unsafe. The frequency of inspection must be determined by the individual application.

**The following list gives an inspection procedure for normal usage under normal conditions.**

When the unit is subjected to heavy usage or dusty, gritty, moist or corrosive atmospheric conditions, shorter time periods must be assigned. Inspection must be made of all parts for unusual wear, corrosion or damage, in addition to those specifically mentioned in the schedule below. Make certain that the unit is complete and contains all parts including hook latches and end ring.

Any parts that are deemed unserviceable must be replaced with new parts before the unit is returned to service. It is very important that the unserviceable parts be destroyed and properly disposed of to prevent their possible future use as a repair item. Use only Columbus McKinnon supplied repair parts as other parts may look the same but may not be to proper

specifications.

Inspection of hoists is divided into two general classifications designated as "frequent" and "periodic".

### FREQUENT INSPECTIONS

These inspections are by the operator or other designated personnel. Frequent inspections are to be performed daily or prior to each use and they are to include the following:

- A. Check for free movement of lever, lever plunger, trigger and ratchet plunger.
- B. Operate hoist with no load and check for visual signs or abnormal noises that could indicate a potential problem.
- C. Check brake for evidence of slippage.
- D. Check chain for lubrication, wear damaged links or foreign material (see page 6).
- E. Check hooks for damage, cracks, twist, latch engagement and latch operation (see page 6).
- F. Check lever for bends, cracks and damage.

- G. Check support or anchor for damage.
- H. Check reeving of chain (see page 9).

Any deficiencies noted during the frequent inspections must be corrected before using the hoist.

### PERIODIC INSPECTIONS

These are visual inspections by an appointed person who records conditions to provide a basis for a continuing evaluation of the hoist. Periodic inspections are to be performed semi-annually and they should include the following:

- A. All items listed under frequent inspections.
- B. Evidence of loose screws.
- C. Evidence of worn, cracked, damaged or distorted lower hook blocks, frame, end ring, loose end link, hook block screws, lever, gears, bushings, lever plunger, lever ratchet hub, brake cam, ratchet, friction hub, liftwheel, chain guide, ratchet plunger, stripper, hoist hanger, lever cap, disc spring, hook nut, hook nut pin, hanger screw, hanger screw nut, hanger screw nut pin, dead end pin, idler sheaves and load limiter parts, as applicable.
- D. Evidence of worn, glazed or oil contaminated friction discs. Friction discs should be replaced if their thickness is less than 0-100 inch (2.5 mm).
- E. Warning label for legibility.

NOTE: To perform some of the periodic inspections, it is necessary to partially disassemble the hoist. Refer to Disassembly-Assembly starting on page 8. Also, the external conditions may show the need for more detailed inspection which, in turn, may require the use of non-destructive type testing.

### HOOK INSPECTION

Hooks damaged from chemicals, deformations or cracks, or that have more than a 10 degree twist from the plane of the unbent hook or excessive opening or seat wear must be replaced.

Also, on latch type hooks, hooks that are opened and allow the latch to disengage the tip, must be replaced.

Any hook that is twisted or has excessive throat opening indicates abuse or overloading of the unit. Other load sustaining components of the hoist should be inspected for damage.

Check to assure latch is not damaged or bent and that it operates properly with sufficient spring pressure to keep the latch tightly against the tip of the hook and allow the latch to spring back to the tip when released. If the latch does not operate properly, it should be replaced.

The charts below (Figures 5 and 6) should be used to determine when the hook must be replaced.

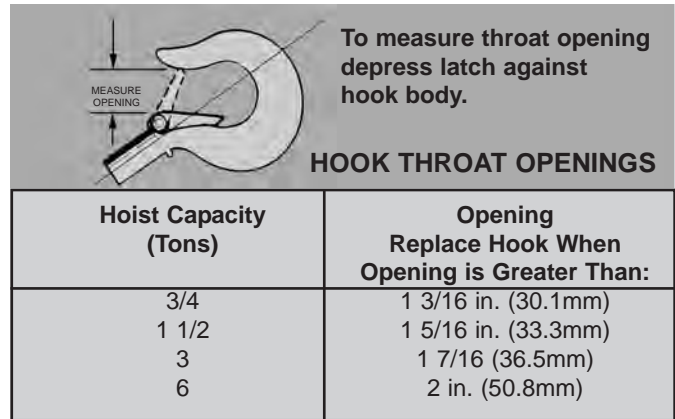

Figure 5. Latchlok Hook Throat Opening

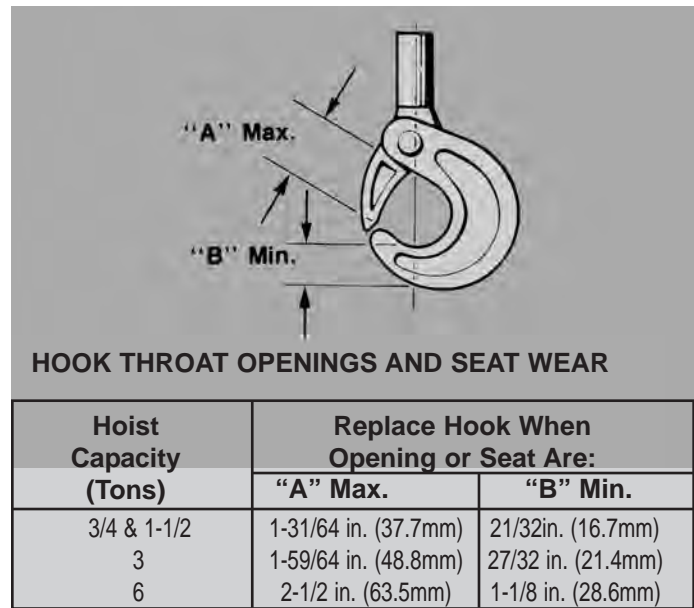
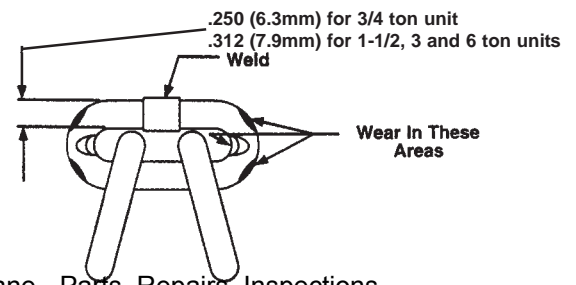

Figure 6. Latchlok Hook Opening  
**CHAIN INSPECTION**

First clean chain with a non-caustic/non-acid type solvent and make a link by link inspection for nicks, gouges, twisted links, weld spatter, corrosion pits, striations (minutes parallel lines), cracks in weld areas, wear and stretching. Chain with any one of these defects must be replaced.

Slack the portion of the chain that normally passes over the liftwheel. Examine the interlink area for the point of maximum wear (polishing). Measure and record the stock diameter at this point of the link. Then measure stock diameter in the same area on a link that does not pass over the liftwheel (use the link adjacent to the end



ring for this purpose). Compare these two measurements. If the stock diameter of the worn link is 0.010 inches (0.254 mm), or more, less than the stock diameter of the unworn link, the chain must be replaced.

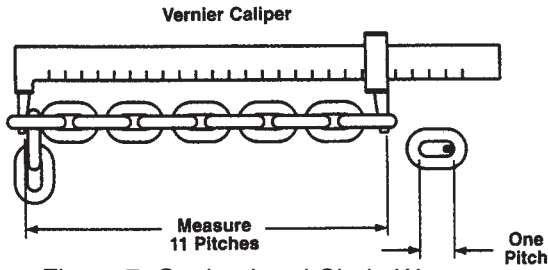

Figure 7. Gaging Load Chain Wear

Also check chain for stretch using a vernier caliper as shown above. Select an unused, unstretched section of chain (usually at the loose end) and measure and record the length over 11 chain links (pitches). Measure and record the same length on a worn section of chain. Obtain the amount of stretch and wear by subtracting the measurement of the unworn section

	<b>WARNING</b>
USING OTHER THAN CM SUPPLIED LOAD CHAIN MAY CAUSE THE CHAIN TO JAM IN THE HOIST AND/OR ALLOW THE CHAIN TO BREAK AND THE LOAD TO DROP.	
<b>TO AVOID INJURY:</b>	
DUE TO SIZE REQUIREMENTS AND PHYSICAL PROPERTIES, USE ONLY CM® HOISTALOY® LOAD CHAIN IN THE CM PULLER.	

from the measurement of the worn section. If the result (amount of stretch and wear) is greater than 0.145 inch (3.7 mm), the chain must be replaced.

Use only a “Knife-Edge” caliper to eliminate possibility of false reading by not measuring full pitch length. Note

that worn chain can be an indication of worn hoist components. For this reason, the hoist’s frame, stripper, and liftwheel should be examined for wear and replaced as necessary when replacing worn chain.

Also, the load chain is specially heat treated and hardened and should never be repaired.

**IMPORTANT:**  
*Do not use replaced chain for other purposes such as lifting or pulling. Load chain may break suddenly without visual deformation. For this reason, cut replaced chain into short lengths to prevent use after disposal.*

## CHAIN LUBRICATION

A small amount of lubricant will greatly increase the life of the load chain. Do not allow the chain to run dry. Keep it clean and lubricate at regular intervals with Lubriplate® Bar and Chain Oil 10-R (Fiske Bros. Refining Co.) or equal lubricant. Normally, weekly cleaning and lubrication is satisfactory, but under hot and dirty conditions, it may be necessary to clean the chain at least once a day and lubricate it several times between cleanings.

When lubricating the chain, apply sufficient lubricant to obtain natural run-off and full coverage, especially in the interlink area.

	<b>WARNING</b>
USED MOTOR OILS CONTAIN KNOWN CARCINOGENIC MATERIALS.	
<b>TO AVOID HEALTH PROBLEMS:</b>	
NEVER USE USED MOTOR OILS AS A CHAIN LUBRICANT. ONLY USE LUBRIPLATE® BAR AND CHAIN OIL 10-R AS A LUBRICANT FOR THE LOAD CHAIN.	

# MAINTENANCE

## LUBRICATION

Except for the load chain (see “Chain Lubrication” above), the hoist requires no additional lubrication.

	<b>WARNING</b>
THE LUBRICANTS USED IN AND RECOMMENDED FOR THE PULLER MAY CONTAIN HAZARDOUS MATERIALS THAT MANDATE SPECIFIC HANDLING AND DISPOSAL PROCEDURES.	
<b>TO AVOID INJURY CONTACT AND CONTAMINATION</b>	
HANDLE AND DISPOSE OF LUBRICANTS ONLY AS DIRECTED IN APPLICABLE MATERIAL SAFETY DATA SHEETS AND IN ACCORDANCE WITH APPLICABLE LOCAL, STATE AND FEDERAL REGULATIONS.	

However, when the unit has been disassembled for cleaning, inspection or repairs, the various part should be lubricated as indicated in “Assembly” start on page 8 using the specified lubricants. If necessary, these lubricants can be obtained from CM® (refer to page 15).

	<b>WARNING</b>
USING ANY GREASE OR LUBRICANT ON THE BRAKING SURFACES WILL CAUSE BRAKE SLIPPAGE AND LOSS OF LOAD CONTROL WHICH MAY RESULT IN INJURY AND/OR PROPERTY DAMAGE.	
<b>TO AVOID INJURY:</b>	
DO NOT USE ANY GREASE OR LUBRICANT ON BRAKING SURFACES. THE BRAKE IS DESIGNED TO OPERATE DRY.	

**Note:** *When lubricating parts adjacent to the brake, do not use an excessive amount of lubricant which could seep onto the brake surfaces.*

## EXTERIOR FINISH

The exterior surfaces of the Puller has a durable, scratch resistant baked powder coating. Normally, the exterior surfaces can be cleaned by wiping with a cloth. However, if the finish is damaged, compatible touch-up paint can be purchased from CM®. Refer to page 16 for information on ordering the paint.

## PREVENTIVE MAINTENANCE

In addition to the above frequent inspection procedure, a maintenance program should be established to prolong the useful life of the tool and maintain its reliability and continued safe use. The program should include the frequent inspections with particular attention being paid to the lubrication of various components using the recommended lubricants. Be sure to completely disassemble the unit every three months and check for excessive wear of the parts as indicated in the following table. Worn parts should be replaced before the Puller is returned to service.

## RECOMMENDED SPARE PARTS

To insure continued operation of the Puller, it is recommended that two friction washers for each Puller in service, Key No. 640-123, Part Number 40904, be kept on hand at all times to replace friction washers that are worn to a thickness of less than .100 inch, contaminated or glazed. Refer to page 11 for ordering instructions.

## DISASSEMBLY

(Refer to pages 11 thru 14 for illustrations and key numbers of parts listed below. Also, see special disassembly instructions on page 17 for units equipped with Load Limiter).

Two points of caution to be observed in disassembly are:

1. When removing the Ratchet Plunger Spring Pin (640-131). This pin retains a spring which is in compression and can spring out.
2. The dead end pin on the 3 and 6 ton units has a tapered spline. Remove this pin by tapping on the end opposite the splined grooves.

## ASSEMBLY

(Refer to pages 11 thru 14 for illustrations and key numbers of parts listed below. Also, see special assembly instructions on page 17 for units equipped with Load Limiter).

**IMPORTANT:** Following assembly test the unit as discussed in the Testing section (page 15).

The following points should be observed when assembling the Puller. Also, refer to the above Warning concerning the brake.

1. **Ratchet Plunger**
  - A. Coat tip and sides of small diameter with a light film of a lubricant consisting of 1 lb.(4.6kg) of graphite #590 (Superior Graphite Co.) and 2 lbs. (.92kg.) of Lubriko M-32 (Master Lubricant Co.).
  - B. The Ratchet Plunger Spring must be held depressed when driving in the Ratchet Plunger Pin thru the lugs on the frame.

2. **Frame Bushing**
  - A. All Frame Bushings should be given a light coating of lubricant as specified above.
3. **Brake Assembly**
  - A. Assemble one Friction Washer.
  - B. Check Bushing in Ratchet (640-124) to be sure it is flush or below the surface of the Ratchet on both sides. Assemble Ratchet with Ratchet Teeth facing as showing in Fig. 8.

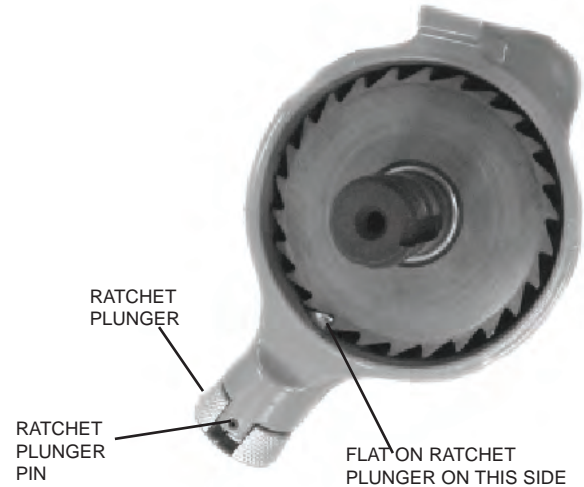

Figure 8. Ratchet and Ratchet Plunger Assembly

- C. Place second Friction Washer on the Ratchet.
- D. Apply a light film of Anderol #786 (Nuodex, Inc.) to the inside diameter of the Lever Ratchet Hub on the second friction washer as shown in Figure 9.
- E. Lubricate Brake Cam (640-126) by coating cam faces and outside surface with a light film of Anderol #786 (Nuodex, Inc.) grease.
- F. Assemble Brake Cam onto shaft then insert Brake Cam Key (640-110) rounded end first - the key must be positioned as shown in Fig. 9.

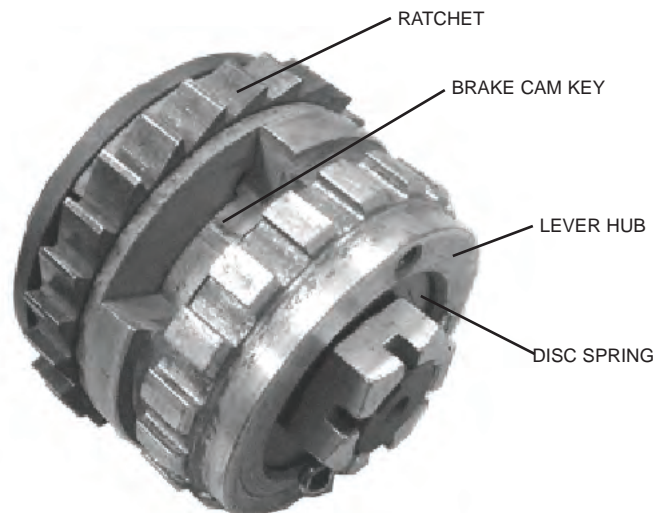
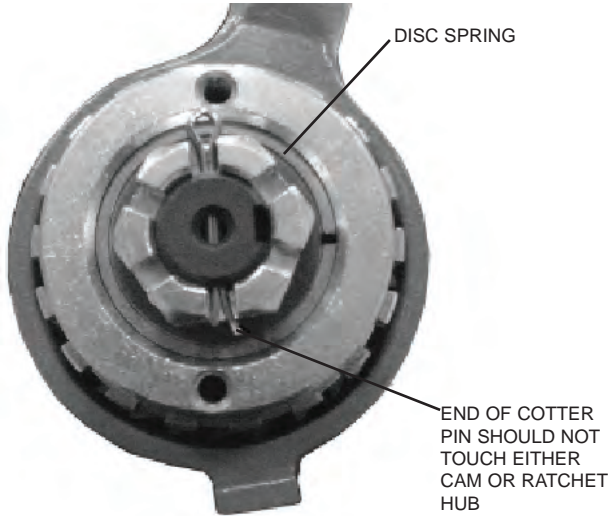

Figure 9. Brake Parts

- G. Turn Lever Ratchet Hub clockwise until vertical ends (shoulders) of the helical surfaces of lever ratchet hub and brake cam are in contact. Place the disc spring on the brake cam with the large end against the brake cam. Assemble brake adjusting nut to shaft and tighten nut until snug. Then continue to tighten nut at least one but no more than two slots in order to align hole in shaft with slot in nut. Insert the cotter pin and



bend the ends of same as shown in Fig. 10.  
Figure 10. Brake Nut Cotter Pin Assembly

4. **Gears**

**(1-1/2, 3 & 6 Ton Units)**

- A. Lubricate the gears with 3-1/2 to 4 oz. (118 ml) of Texaco Novatex #2 Grease or equal, by spreading some on Gear Teeth and balance in the lower portion of Gear Cover.

5. **Chain Guide**

**(1-1/2, 3 & 6 Ton Units)**

- A. When installing the Chain Guide, the Chain Guide Screw must be tightened to a torque of 10 to 13 inch pounds.

6. **Lever Assembly**

- A. Coat Lever Plunger (640-176) tip for a length of 1-1/2 inches(38mm) with a lubricant consisting of 1 oz. of graphite #590 (Superior Graphite Co.) and 1qt. (946 ml) of Acheson #DAG-1556 dry film lubricant (Acheson Collids Co.)
- B. When assembling Lever Trigger (640-180) be sure to maintain relation of Lever Plunger tip and Lever Trigger as shown in Fig. 11.
- C. Coat inside of Lever Head with Lubriko M-32. Wipe off excess lubricant.

**IMPORTANT:** To assure extra long life and top performance, be sure to lubricate the various parts of the CM® Puller using the lubricants specified

above. If necessary, these lubricants may be purchased from CM®. Refer to page 15 for information on ordering the lubricants.

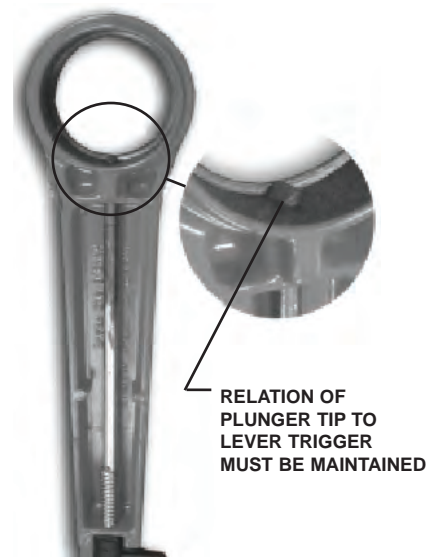

Figure 11. Lever Assembly

**REEVING**

**NOTE:** Units should be in the free wheeling mode before reeving. See page 4.

A. **3/4 Ton Unit Uses CM® 1/4 in. (6.3mm) Stock Disc Grade Load Chain.**

Start upstanding link (see Fig. 12) of hook end of load chain into Plunger Boss side (at side opposite that is marked on the chain guide "Lower Hook Side") of clover leaf chain guide and onto liftwheel with weld side of upstanding links facing away from liftwheel. Continue to feed chain into opening while turning Lever Cap clockwise until end of chain can be reached and pulled through. Do not force chain over liftwheel - if turning of Lever Cap becomes difficult, back off and start over - otherwise, the chain could become jammed between liftwheel and frame.



Figure 12. Chain Assembly - Hook End, 3/4 Ton

**B. 1-1/2 Ton Unit Uses CM® 5/16 in. (7.9mm) Stock Disc Grade Load Chain.**

Start upstanding link (see Fig. 13) of hook end of load chain onto liftwheel (at side opposite that marked on casting "Lower Hook Side") with weld side of upstanding links facing away from liftwheel (at side opposite that marked on casting "Lower Hook Side") with weld side of upstanding links facing away from liftwheel. Continue to feed chain onto liftwheel while turning Lever Cap clockwise until end of chain can be reached and pulled through. Do not force chain over liftwheel - if turning of Lever Cap becomes difficult, back off and start over - otherwise, the chain could become jammed between liftwheel and frame.



Figure 13. Chain Assembly - Hook End, 1 1/2 Ton

**C 3 Ton Uses CM® 5/16 in. (7.9mm) Stock Disc Grade Load Chain.**

a. Start upstanding link (see Fig. 13) of dead end (end opposite end ring) onto liftwheel (at side opposite that marked on casting "Lower Hook Side") with weld side of upstanding links facing away from liftwheel. Continue to feed chain onto liftwheel while turning Lever Cap clockwise until end of chain can be reached. Pull through about three feet of chain. Do not force chain over liftwheel - if turning of Lever Cap becomes difficult, back off and start over - otherwise, the chain could become jammed between liftwheel and frame.

b. Place the Puller in vertical position.  
 c. After checking to be sure there is no twist in chain, feed end of chain through Hook Block and around Lower Sheave.  
 d. Secure end of chain to Hoist Hanger with Dead End Pin (640-144)

**D. 6 Ton Unit Uses CM® 5/16 in. (7.9mm) Stock Disc Grade Load Chain.**

a. Start first link of dead end (end opposite End Ring) onto Liftwheel in flat position (at side opposite that marked on casting "Lower Hook Side") with weld side of upstanding links facing away from Liftwheel. Continue to feed chain onto Liftwheel while turning Lever Cap clockwise until end of chain can be reached. Pull through about six feet of chain. Do not force Chain over



Figure 14.  
Reeving 3-Ton

Liftwheel if turning of Lever Cap becomes difficult, back off and start over - otherwise, the chain could become jammed between Liftwheel and Frame.

- b. Place the Puller in vertical position.
- c. After studying Fig. 15 and checking to be sure there is no twist in chain, feed end of chain down through Hook Block and around one lower Sheave, up over upper Sheave, down through Hook Block and around second lower Sheave.
- d. Secure end of chain to the Hanger with Dead End Pin (640-147).

**E. All Units**

- a. Lubricate chain with Lubriplate®, Bar and Chain Oil 10-R (Fiske Bros. Refining Co.) or equal Lubricant.
- b. **Important: Load Chain End Ring should be assembled and left on end of the load chain to prevent chain from being run out of unit.**



Figure 15.  
Reeving  
6-Ton

**F. 3/4 and 1-1/2 Ton Units**

- a. Coat undersides of hook Knob and Seat of Hook Blocks with a light film of Lubriko M-32 (Master Lubricants Co.) or equal grease.
- b. After tightening Hook Block Screw, lock in place by prick punching two spots 180 apart on edge of counterbore to drive metal in to serrations of head of screw. If screw has been removed and replaced, always use new spots for locking.

**G. Test the unit as discussed in the Testing section (page 15).**

# REPAIR PARTS

## ORDERING INFORMATION

The following information must accompany all correspondence or repair parts orders.

- 1) Puller capacity
- 2) Serial Number - this is stamped on the Puller frame (640-100 or 640-101).

For parts orders also specify

- 1) Quantity desired
- 2) Key number of part
- 3) Part Name
- 4) Part number of the part

When ordering replacement parts, consideration should be given to the need to replace other items, (bushings, fasteners, etc.) and items that may be damaged or lost during disassembly or just unfit for future use because of

deterioration from age or service.

Parts should be ordered from CM's® Master Parts Depots conveniently located throughout the United States and Canada. Refer to the inside of the front cover of this manual to locate the Master Parts Depot nearest you.

 <span style="font-size: 24pt; font-weight: bold; margin-left: 10px;">WARNING</span>
<p style="margin: 0;">USING "COMMERCIAL" OR OTHER MANUFACTURER'S PARTS TO REPAIR THE CM® PULLERS MAY CAUSE LOAD LOSS.</p>
<p style="margin: 0; text-align: center;"><b>TO AVOID INJURY:</b></p> <p style="margin: 0;">USE ONLY CM® SUPPLIED REPLACEMENT PARTS. PARTS MAY LOOK ALIKE BUT CM® PARTS ARE MADE OF SPECIFIC MATERIALS OR PROCESSED TO ACHIEVE SPECIFIC PROPERTIES.</p>

CM® PULLER PARTS LIST						
KEY NO.	NO. REQ'D.	PART NAME	PART NUMBER			
			CAPACITY - TONS			
			3/4	1½	3	6
640-100	1	Frame with Bushings (3/4 Tons)	40684C	-		
640-101	1	Frame with Bushings (1½-6 Tons)	-	40695C	40695C	
640-102	1	Frame Expansion Plug	940787	-		
640-103	1	Stripper Screw	982688	-		
640-104	2	Chain Guide Attaching Screw	987274	-		
640-105	1	Stripper	40728	-		
640-106	2	Gear Cover Screw	-	982689		
640-107	1	Chain Guide Attaching Screw	-	982565		
640-108	1	Friction Hub Key	-	40917		
640-109	1	Pinion Thrust Washer	-	40789		
640-110	1	Brake Cam Key	40824			
640-111	1	Brake-Adjusting Nut	40785			
640-112	1	Brake Adjusting Nut Cotter Pin	940805			
640-113	2	Lever Cap Screw	982717			
640-114	1	Liftwheel	40130	40140		
640-115	1	Chain Guide	40698B	24718		
640-116	1	Liftwheel Bushing (Gear End)	-	40816		
640-117	1	Liftwheel Bushing (Brake End)	-	40817		
640-118	1	Pinion Shaft Bushing (Brake End)	-	40818		
640-119	1	Pinion Shaft Bushing (Pinion End)	-	40819		
640-120	1	Gear Cover	-	40209	40217	
640-121	1	Pinion Shaft	-	40480		
640-122	1	Friction Hub	-	40446		
640-123	2	Friction Washer	40904			
640-124	1	Ratchet with Bushing	40662			
640-125	1	Lever Ratchet Hub For Units Not Equipped With Load Limiter	40570			
640-126	1	Brake Cam	40122			
640-127	1	Lever Assembly (Includes Lever, Expansion Plug, Plunger, Plunger Spring, Spring Pin Trigger, Trigger Pin, Warning Label and Nameplate)	40663 For Units Without Load Limiter 40928 For Units With Load Limiter			
640-128	1	Load Sentry Assembly	4096	4098		
640-129	1	Ratchet Plunger	40517			
640-130	1	Ratchet Plunger Spring	40742			
640-131	1	Ratcher Plunger Spring Pin	983880			
*640-132	1	Upper Hook Assembly (Includes Latch)	40601	40603	40605	40607
640-133	1	Upper Hook Nut or Collar	986383	40445	40382	70393
640-134	1	Upper Hook Pin	983768	45841	982335	983787
640-135	1	Upper Hook Washer	-			40736
640-136	1	Anchor Sling	4071	4072	-	
640-137	1	Lever Cap	40576			

CM® PULLER PARTS LIST-(Continued)						
KEY NO.	NO. REQ'D.	PART NAME	PART NUMBER			
			CAPACITY - TONS			
			3/4	1½	3	6
640-138	1	Disc Spring	82297			
640-139	1	End Ring	40471			
640-140	1	Hoist Hanger	-		40151C	40171C
640-141	1	Adapter Sleeve	-		40790	-
640-142	1	Hanger Screw (3Ton)	-		982587	-
640-143	1	Hanger Screw Washer (3 Ton)	-		940807	-
640-144	1	Dead End Pin (3 Ton)	-		40851	-
640-145	1	Hoist Hanger Set Screw (3 Ton)	-		986304	-
640-146	1	Hanger Screw (6 Ton)	-			40500
640-147	1	Dead End Pin (6 Ton)	-			40853
640-148	1	Bearing Retainer Snap Ring	-			40740
640-149	1	Hanger Screw Washer (6 Ton)	-			45930
640-150	1	Hanger Screw Nut (6 Ton)	-			40383
640-151	1	Hanger Screw Nut Pin (6 Ton)	-			983791
640-152	1	Upper Sheave	-			40172
640-153	2	Upper Sheave Bearing	-			88429
*640-154	1	Lower Hook Assembly (Includes Latch)	40602	40604		-
640-155	1	Hook Block Drilled	40120	40142		-
640-156	1	Hook Block Tapped	40121	40143		-
640-157	1	Hook Block Screw	40854	40855		-
*640-158	1	Lower Hook Assembly (Includes Latch)	40602	40604	40606	40608
640-159	1	Lower Hook Washer	-		50454	40736
640-160	1	Lower Hook Nut	-		40382	70393
640-161	1	Lower Hook Nut Pin	-		982335	983787
640-162	3	Lower Hook Block Screw	-		940812	-
640-163	3	Lower hook Block Screw L.W.	-		940830	-
640-164	3	Lower Hook Block Screw Nut	-		945820	-
640-165	1	Reeving Caution Plate	-		40930	-
640-166	1	Lower Sheave Bearing Spacer	-			40796
640-167	2	Bearing Retainer Snap Ring	-			40740
640-168	2	Expansion Plug	-			940737
640-169	1	Lower Sheave (3 Ton)	-		40166	-
640-170	2	Lower Sheave (6 Ton)	-			40172
640-171	4	Sheave Bearing (6 Ton)	-			88429
640-172	2	Lower Hook Block (3 Ton)	-		40689C	-
640-173	1	Lower Hook Block (6 ton)	-			40176C
640-174	1	Load Chain (Specify length required)	85839		85847	
640-175	2	Latch Kit	45661	45662	45663	45665
640-176	1	Lever Plunger			40462	
640-177	1	Lever Expansion Plug			940801	
640-178	1	Lever Plunger Spring			40735	
640-179	1	Lever Plunger Pin			983766	
640-180	1	Lever Trigger			40113	
640-181	1	Lever Trigger Pin			983768	
640-183	1	Warning Label	40975	40978	40979	40980
640-184	1 Ea.	Operating Tag and Tie	Order Tag 40976 and Tie 982979			
640-200	1	Load Limiter Kit (Includes Lever)	4190		4191	
640-201	1	Lever Ratchet Hub for Units Equipped with Load Limiters			40182	
640-202	1	Capacity or CM Label	-	40908		40907

\* If Latchlok Hook is required, part numbers are:

Upper Hook-1000 for 3/4 ton, 1002 for 1-1/2 ton, 1004 for 3 ton and 1027 for 6 ton.

Lower Hook-1001 for 3/4 ton, 1003 for 1-1/2 ton, 1005 for 3 ton and 1007 for 6 ton.



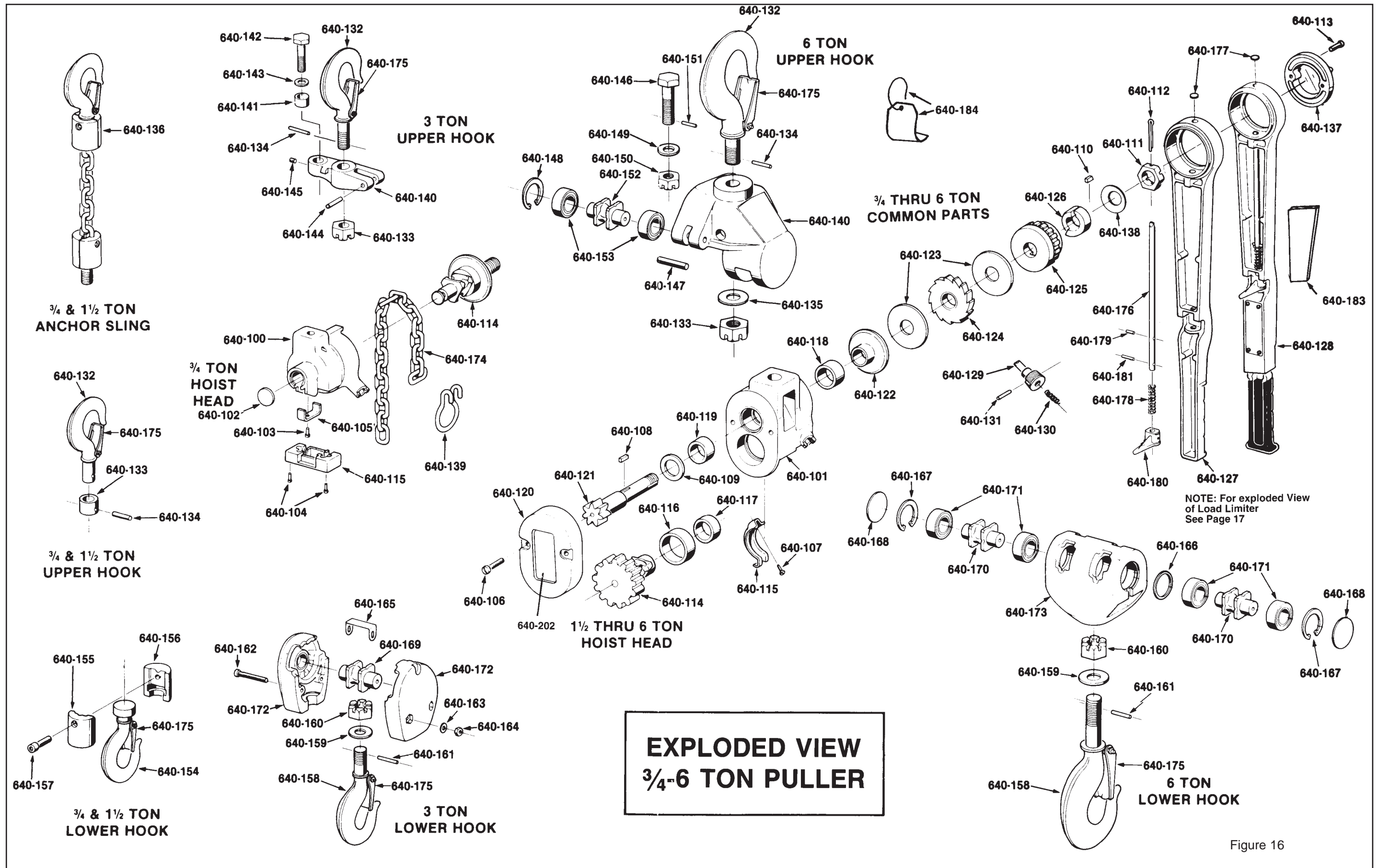

Figure 16

PART NUMBERS FOR PACKAGED LUBRICANTS USED IN THE PULLERS (REFER TO PAGES 7,8 AND 9 FOR LUBRICATION INSTRUCTIONS)		
LUBRICANT USAGE	TYPE OF LUBRICANT	PART NUMBERS AND PACKAGED QUANTITIES OF LUBRICANTS
TIP OF RATCHET PLUNGER AND SEAT FOR KNOB HOOK	GREASE-GRAPHITE MIXTURE	40626 (1 LB., 46 kg. CAN)
TIP OF LEVER PLUNGER AND BRAKE CAM	DRY-LUBE-OIL-GRAPHITE MIXTURE	40553 (½ LB., .23 kg CAN)
FRAME BEARINGS AND INSIDE OF LEVER HEAD	GREASE	40630 (1 LB., .46 kg. CAN)
GEARS (1½, 3 AND 6 TON UNITS)	GREASE	28610 (1 LB., .46 kg. CAN) 28613 (4 LB., 1.8 kg. CAN)
BETWEEN UPPER HOOK NUT AND WASHER	GREASE-GRAPHITE MIXTURE	40626 (1 LB., .46kg. CAN)
LOAD CHAIN	OIL	28608 ( 1 PT., .5L CAN) 28619 ( 1 GAL., 3.8L CAN)

When ordering lubricants, specify the type of lubricant, part number and packaged quantity required.

Touch-up paint for the Puller:

\* (1) case (12-12 oz., 354 ml Aerosol Cans) of Orange Touch-up Paint Part Number 84190.

\*Touch-up paints are only available in case quantities.

**NOTE: When painting the Pullers, also order warning labels and capacity labels that may be coated during painting.**

### CUTTING CHAIN

CM® Hoistaloy® load chain is hardened for wear resistance and is difficult to cut. However, the following methods are recommended when cutting off a length of worn chain.

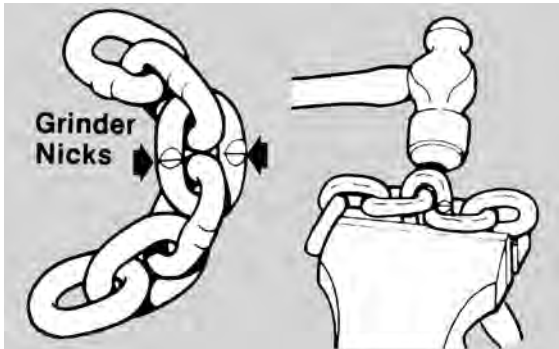

Figure 17. Cutting Chain by nicking

- (1) Use a grinder and nick the link on both sides (Figure 16), then secure the link in a vise and break off with a hammer.
- (2) Use a 7 inch (178mm) minimum diameter by 1/8 inch (3.17mm) thick abrasive wheel (of type recommended by wheel supplier) that will clear adjacent links.

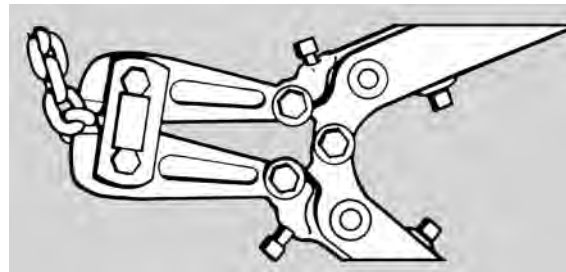

Figure 18. Cutting Chain with a Bolt Cutter

- (3) Chain may also be cut using a blot cutter (Figure 17) similar to the H.K. Porter No. 0590MTC with special cutter jaws for cutting hardened chain (1 inch., 25.4mm) long cutting edge).

### TESTING

Prior to initial use, all altered or repaired hoists or used hoists that have not been operated for the previous 12 months shall be tested by the user for proper operation.

Test the unit first in the unloaded state and then with a light load of 100 pounds (45kg.) time the number load supporting parts of load chain to be sure it operates properly and the brake holds the load when the lever is released; then test with a load of 125% of rated capacity.

In addition, hoists in which load sustaining parts have been replaced shall be tested with 125% of rated capacity by or under the direction of an appointed person and a written report prepared for record purposes.

	<b>WARNING</b>
CUTTING CHAIN CAN PRODUCE FLY PARTICLES.	
TO AVOID INJURY:	
<ul style="list-style-type: none"> <li>• WEAR EYE PROTECTION</li> <li>• PROVIDE A SHIELD SUCH AS A HEAVY RAG OVER CHAIN TO PREVENT FLYING PARTICLES.</li> </ul>	

## TROUBLE SHOOTING

For disassembly and assembly follow instructions on pages 7 thru 10. Always test the CM® Puller under load after reassembly of any parts to be sure it operates properly and holds the load when the lever is released.

IF TOOL	CAUSE MAY BE	CHECK AND REMEDY
1. is hard to operate in either direction	A) Load chain worn long to gauge, thus binding between liftwheel and frame.	A) Check chain, (see page 7) and replace if worn excessively.
	B) Load chain rusty, corroded or clogged with foreign matter such as cement or mud.	B) Clean chain by tumble polishing or using a non-acid or non-caustic type solvent. Check chain for gouges, damaged or bent links. Lubricate with Lubriplate®, Bar and Chain Oil 10-R (Fiske Bros. Refining Co.) or equal lubricant.
	C) Bushings clogged with matter such as cement and dust.	C) Disassemble and clean liftwheel bushings, pinion shaft bushings, ratchet bushings, and sliding surfaces of ratchet plunger and lever plunger. Any parts worn excessively should be replaced.
	D) Lever head binding on frame.	D) Clean by removing any foreign matter which may be between the head of the lever and the frame section surrounding the brake.
	E) Brake parts corroded or clogged with foreign matter.	E) Disassemble brake and clean thoroughly (by wiping with a cloth - not by washing in a solvent). Replace washers if too gummy, worn or scored. Keep washers and brake surfaces clean and dry.
	F) Liftwheel pockets clogged with foreign matter or worn excessively causing chain to bind between liftwheel and frame.	F) Clean out pockets and use if not worn excessively.
	G) Liftwheel twisted or bent - gear teeth bent. ( 1 1/2, 3 & 6-ton only).	G) Excessive overload had been applied Replace damaged parts.
2. is hard to operate in down direction.	A) Brake adjusting nut is too tight.	A) See instructions on brake assembly, page 8.
	B) Brake parts corroded or clogged with foreign matter.	B) See item 1E.
	C) Chain binding in frame.	C) See items 1A and 1B.
3. is hard to operate in up direction.	A) Chain binding in	A) See Items 1A and 1B.
	B) Chain twisted- 3 & 6-ton only.	B) Re-reeve chain or on 3-ton unit, if both chains are twisted, capsize hook block through loop in chain until twists are removed. <b>Caution:</b> Do not operate the Puller in the up direction with twisted chain or chain may become jammed in frame or hook block.
	C) Overload.	C) Reduce load or use correct capacity unit.

# LOAD LIMITER

The Load Limiter is a friction device that is designed and factory calibrated to prevent the lifting of excessive overloads with the 3/4, 1-1/2, 3 and 6 Ton Pullers with Standard Levers. Excessive overload is indicated by lever movement without the corresponding movement of the lower hook block or load when the unit is operated in the "Up" direction. Should overload be evident, immediately switch the trigger to "Down" direction and operate the lever to remove the excess load from the unit. The reduction of the load to rated capacity or less will result in automatic restoration of normal operation.

## CAUTION

The Load Limiter is subject to overheating and wear when excessively actuated. For this reason once overloading is detected, the excess load must be removed and normal operation restored without continued undue operation.

The Load Limiter is designed to operate dry without lubrication. Therefore, to assure proper operation, do not apply lubricant to friction surfaces or to adjacent parts of the Load Limiter.

**Follow all the instructions and warnings per pages 3 thru 10 when installing, operating, inspecting and maintaining the Puller equipped with the Load Limiter. When disassembling and reassembling the Load Limiter, refer to Figure 19 and observe the following:**

1. To aid in its removal, the hole in the key is threaded. If it is difficult to remove, thread a #10-24 UNC-2A screw into the hole and pull on the screw to remove the key.
2. Place the spacers in the recess of the outer cone and place the Load Limiter spring on top of the spacers.

3. Be sure to tighten the socket head cap screw to a seating torque of 200 to 250 pound inches (22.6 to 28.2nm). If the screw does not remain tight, apply locking compound, such as VC-3 (Nylok-Detroit) to the threads of the screw per the manufactures recommendations.

Under certain operating conditions, such as applying an overload or removing the load by external means, the brake may become locked. This results in not being able to operate the Puller in the "DN" direction. Should this occur, reapply a load to the lower hook. Place the trigger in the "DN" position and give the lever a sharp pull and then a few additional strokes to lower the load and remove the tension from the Puller.

When testing the unit per page 16, reduce the test load to rated capacity if the lever should slip when attempting to lift the 125% of rated capacity load. After this test, the function of the load limiter should be checked. To do this, attach the lower hook to a load of 180% of rated capacity and operate the unit in the "up" direction. When attempting to lift this load, the lever should slip. After this test, move the trigger to the down position and operate the lever to remove the tension from unit.

Since each Load Limiter is individually calibrated, the components of the device are not sold separately as repair parts. If replacement is necessary order the appropriate Load Limiter Kit (refer to parts list). However, the lever ratchet hub, and lever assembly (as well as the components of the lever assembly) used on a Puller equipped with a Load Limiter can be ordered as repair parts. (Refer to exploded view and parts list on pages 11 thru 14).

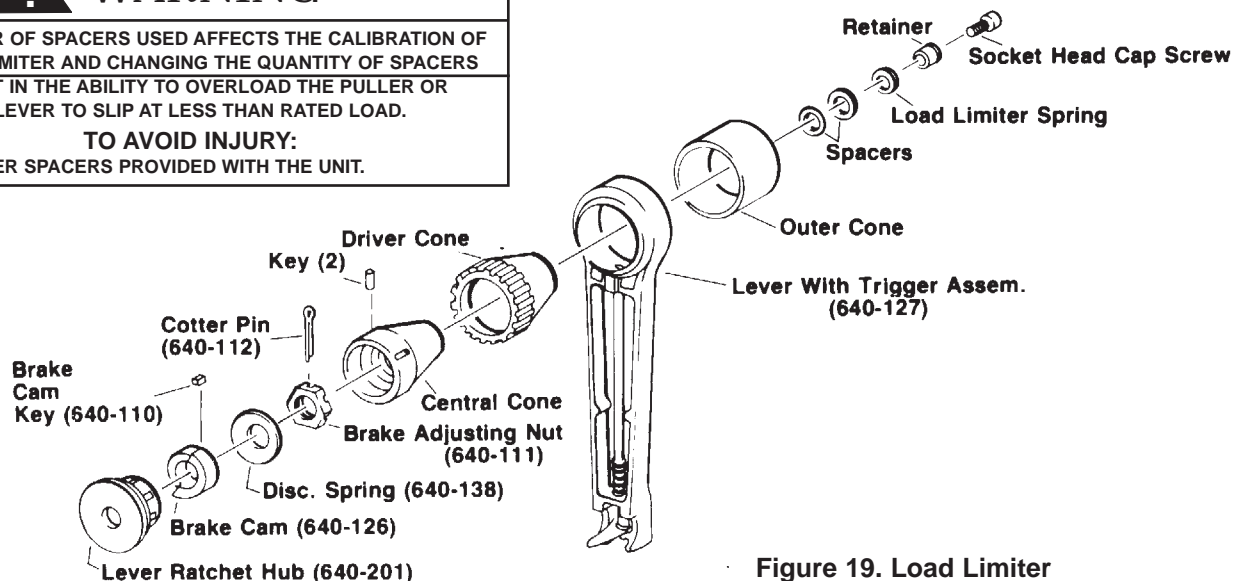
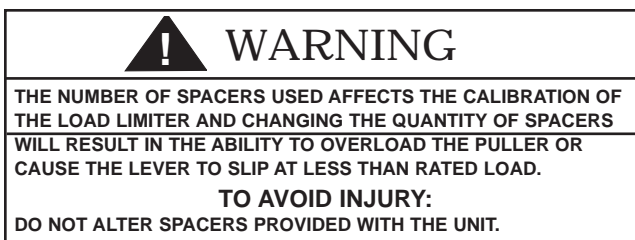

Figure 19. Load Limiter

Note: When ordering parts, always furnish rated load and serial number of hoist on which the parts are to be used.

For the location of the nearest CM® Master Parts Depot, see the list located on the inside front cover.

**LIMITATION OF WARRANTIES, REMEDIES AND DAMAGES**

THE WARRANTY STATED BELOW IS GIVEN IN PLACE OF ALL OTHER WARRANTIES, EXPRESS OR IMPLIED, OF MERCHANTABILITY, FITNESS FOR A PARTICULAR PURPOSE, OR OTHERWISE, NO PROMISE OR AFFIRMATION OF FACT MADE BY ANY AGENT OR REPRESENTATIVE OF SELLER SHALL CONSTITUTE A WARRANTY BY SELLER OR GIVE RISE TO ANY LIABILITY OR OBLIGATION.

Seller warrants that on the date of delivery to carrier the goods are free from defects in workmanship and materials.

SELLER'S SOLE OBLIGATION IN THE EVENT OF BREACH OF WARRANTY OR CONTRACT OR FOR NEGLIGENCE OR OTHERWISE WITH RESPECT TO GOODS SOLD SHALL BE EXCLUSIVELY LIMITED TO REPAIR OR REPLACEMENT, F.O.B. SELLER'S POINT OF SHIPMENT, OF ANY PARTS WHICH SELLER DETERMINES TO HAVE BEEN DEFECTIVE or if Seller determines that such repair or replacement is not feasible, to a refund of the purchase price upon return of the goods to Seller.

Any action against Seller for breach of warranty, negligence or otherwise, must be commenced within one year after such cause of action accrues.

NO CLAIM AGAINST SELLER FOR ANY DEFECT IN THE GOODS SHALL BE VALID OR ENFORCEABLE UNLESS BUYER'S WRITTEN NOTICE THEREOF IS RECEIVED BY SELLER WITHIN ONE YEAR FROM THE DATE OF SHIPMENT. Seller shall not be liable for any damage, injury or loss arising out of the use of the goods if, prior to such damage, injury or loss, such goods are (1) damaged or misused following Seller's delivery to carrier; (2) not maintained, inspected, or used in compliance with applicable law and Seller's written instructions

and recommendations; or (3) installed, repaired, altered or modified without compliance with such law, instructions or recommendations.

UNDER NO CIRCUMSTANCES SHALL SELLER BE LIABLE FOR INCIDENTAL OR CONSEQUENTIAL DAMAGES AS THOSE TERMS ARE DEFINED IN SECTION 2-715 OF THE UNIFORM COMMERCIAL CODE.

**INDEMNIFICATION AND SAFE OPERATION**

Buyer shall comply with and require its employees to comply with directions set forth in instructions and manuals furnished by Seller and shall use and require its employees to follow such instructions and manuals and to use reasonable care in the use and maintenance of the goods. Buyer shall not remove or permit anyone to remove any warning or instruction signs on the goods. In the event of personal injury or damage to property or business arising from the use of the goods, Buyer shall within 48 hours thereafter give Seller written notice of such injury or damage. Buyer shall cooperate with Seller in investigating any such injury or damage and in the defense of any claims arising therefrom.

If Buyer fails to comply with this section or if any injury or damage is caused, in whole or in part, by Buyer's failure to comply with applicable federal or state safety requirements, Buyer shall indemnify and hold Seller harmless against any claims, loss or expense for injury or damage arising from the use of the goods.

	<b>WARNING</b>
<b>ALTERATIONS OR MODIFICATIONS OF EQUIPMENT AND USE OF NON-FACTORY REPAIR PARTS CAN LEAD TO DANGEROUS OPERATION AND INJURY.</b>	
<b>TO AVOID INJURY:</b>	
<ul style="list-style-type: none"> <li>• DO NOT ALTER OR MODIFY EQUIPMENT</li> <li>• DO USE ONLY FACTORY PROVIDED REPLACEMENT PARTS</li> </ul>	



Columbus McKinnon Corporation • 140 John James Audubon Parkway  
Amherst, New York 14228-1197 • 1-800-888-0985 • Fax 716-689-5644