

WEAR-FLEX

Protective Nylon Slings

Distributed By:

McLaughlin Hoist & Crane

Fenton, Missouri

(636)343-9700

www.StLCrane.com

SAFE-LINE PROTECTIVE NYLON SLINGS

PERMANENTLY WOVEN "BLACK LINE" RATED CAPACITY IDENTIFICATION

Safe-Line Slings are available in two web strengths and both have permanent black line identification.

One black line identifies slings with 1/2 ton rated capacity per inch width of each sling leg. **(1000 Lbs.)**

Two black lines identify slings with 1 ton rated capacity per inch width for each sling leg. **(2000 Lbs.)**

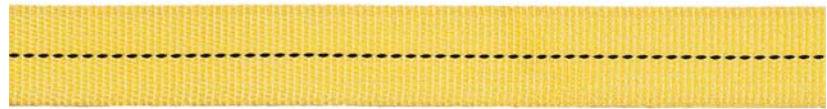

Single Strength – 1 Black Line, 1/2 ton (1000 Lbs.) per inch width

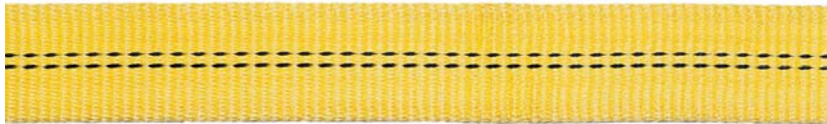

Double Strength – 2 Black Lines, 1 ton (2000 Lbs.) per inch width

SAFE-LINE SLINGS HAVE SAFER, LOWER COST, SINGLE PLY CONSTRUCTION



SINGLE PLY ADVANTAGES:

- Softer
- Lighter
- More Flexible
- Easier to Handle
- Longer Wearing

Safe-Line is a complete line of single ply slings offering up to 33% more strength than competitors' single ply slings. The Wear-Flex development of single and double strength webbing eliminates the need for two-ply construction.

TWO PLY DISADVANTAGES:

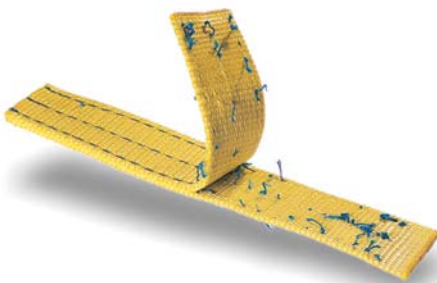

The two-ply construction that competitors use to make slings of comparable strength costs up to 50% more than Safe-Line Slings.

REASONS WHY SAFE-LINE PROTECTIVE NYLON SLINGS ARE THE **BEST** IN THE INDUSTRY

TEXTURIZED NYLON "ARMOR JACKET" PROTECTION

A tough external jacket of texturized nylon yarns protects the internal load carrying yarns. Texturized nylon yarns have more than 100% better wear abrasion resistance than regular lifting yarns.

PERMANENTLY WOVEN "BLACK LINE" RATED CAPACITY IDENTIFICATION

These woven Black Lines permanently identify the rated capacity of all Safe-Line Slings.

RED "SAFETY ALERT" PROTECTION

Safe-Line Slings have red inner warning yarns that show when the tough texturized nylon "Armor Jacket" is cut or damaged exposing the inner load carrying yarns.

Safe-Line Slings are impregnated with a chemical compound to seal out dirt and foreign particles and improve non-slip quality.

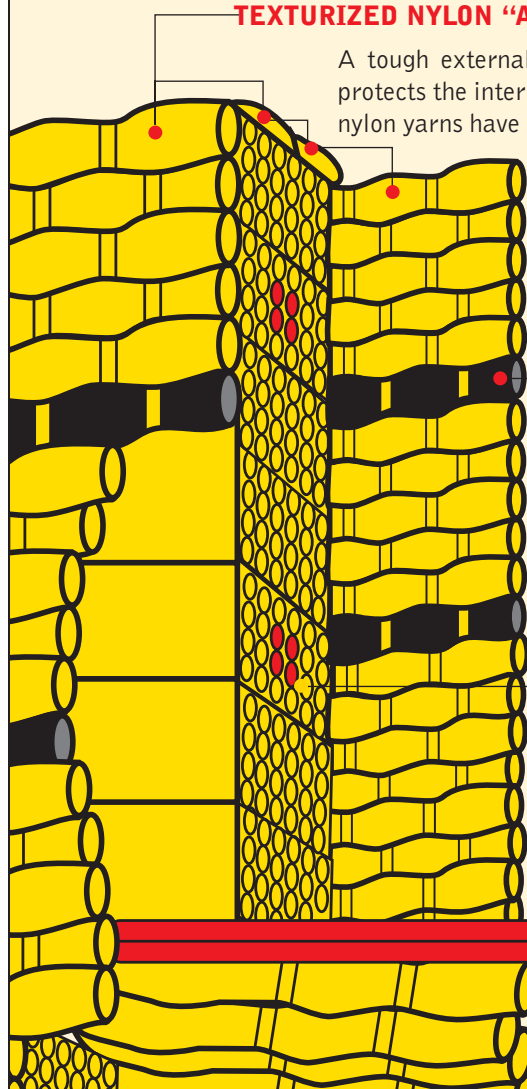

SAFE-LINE SPECIAL SAFE-TOTE OFFERS

3 SAFE-TOTE SLINGS

Soft 1" wide Endless Nylon Slings packaged in a convenient flip-top box.



MARK III SAFE-TOTE SLINGS

1" wide x 30" long Box of 3
 SAVE \$1.65 \$34.00 value ONLY \$32.35

MARK IV SAFE-TOTE SLINGS

1" wide x 40" long Box of 3
 SAVE \$2.05 \$39.05 value ONLY \$37.00

MARK V SAFE-TOTE SLINGS

1" wide x 50" long Box of 3
 SAVE \$2.25 \$44.10 value ONLY \$41.85

COMBO SAFE-TOTE SLINGS

1 Mark III, IV, V
 SAVE \$2.05 \$39.05 value ONLY \$37.00

Rated Capacity: Choker 1600 Lbs. @ 30°
 Vertical 2000 Lbs. @ 90°
 Basket 4000 Lbs. @ 90°



ENDLESS SAFE-LINE SLINGS

UNIT PACKED
 10 SLINGS PER BOX

1" WIDE ENDLESS SLINGS			
Rated Capacity: Choker 3200 Lbs. @ 30°, Vertical 4000 Lbs. @ 90°, Basket 8000 Lbs. @ 90°			
1 Box	EN-2001 x 3 Ft.	10 Slings	\$191.85
1 Box	EN-2001 x 4 Ft.	10 Slings	218.90
1 Box	EN-2001 x 5 Ft.	10 Slings	245.85
1 Box	EN-2001 x 6 Ft.	10 Slings	272.90
1 Box	EN-2001 x 8 Ft.	10 Slings	326.90
1 Box	EN-2001 x 10 Ft.	10 Slings	380.95

2" WIDE ENDLESS SLINGS			
Rated Capacity: Choker 6400 Lbs. @ 30°, Vertical 8000 Lbs. @ 90°, Basket 16000 Lbs. @ 90°			
1 Box	EN-2002 x 3 Ft.	10 Slings	\$302.10
1 Box	EN-2002 x 4 Ft.	10 Slings	355.60
1 Box	EN-2002 x 5 Ft.	10 Slings	409.05
1 Box	EN-2002 x 6 Ft.	10 Slings	462.55
1 Box	EN-2002 x 8 Ft.	10 Slings	569.50
1 Box	EN-2002 x 10 Ft.	10 Slings	676.40

1" WIDE ENDLESS SLINGS			
Rated Capacity: Choker 1600 Lbs. @ 30°, Vertical 2000 Lbs. @ 90°, Basket 4000 Lbs. @ 90°			
1 Box	EN-1001 x 3 Ft.	10 Slings	\$111.30
1 Box	EN-1001 x 4 Ft.	10 Slings	127.40
1 Box	EN-1001 x 5 Ft.	10 Slings	143.35
1 Box	EN-1001 x 6 Ft.	10 Slings	159.35
1 Box	EN-1001 x 8 Ft.	10 Slings	191.30
1 Box	EN-1001 x 10 Ft.	10 Slings	223.30

2" WIDE ENDLESS SLINGS			
Rated Capacity: Choker 3200 Lbs. @ 30°, Vertical 4000 Lbs. @ 90°, Basket 8000 Lbs. @ 90°			
1 Box	EN-1002 x 3 Ft.	10 Slings	\$183.00
1 Box	EN-1002 x 4 Ft.	10 Slings	214.45
1 Box	EN-1002 x 5 Ft.	10 Slings	245.85
1 Box	EN-1002 x 6 Ft.	10 Slings	277.30
1 Box	EN-1002 x 8 Ft.	10 Slings	340.15
1 Box	EN-1002 x 10 Ft.	10 Slings	403.00

WARNING!
 DO NOT EXCEED RATED CAPACITIES. REFER TO SLING LOAD CHART ON PAGE 5 FOR RATED CAPACITIES AT OTHER SLING-TO-LOAD ANGLES.

SAFE-LINE PROTECTIVE NYLON SLINGS

ENDLESS (EN)

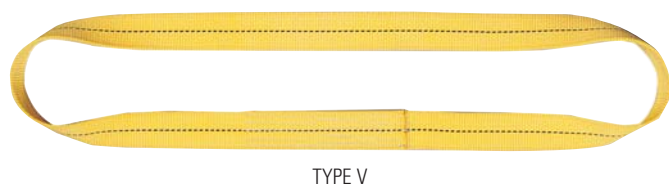

The Safe-Line Endless Sling is the strongest, most popular, efficient and economical sling. It can be used in a choker, vertical or basket hitch. In a basket hitch, the legs can be spread for added stability. Load contact points change with every lift, increasing sling life and safety.

Order by Stock No. and Length	Sling Width Inches	Rated Capacity – Lbs.			User List Price	
		Choker @ 30°	Vertical @ 90°	Basket @ 90°	3 Foot Base Price	Adder Per Foot
EN-1001	1"	1600	2000	4000	\$11.35	\$1.70
EN-2001	1"	3200	4000	8000	19.60	2.80
EN-1002	2"	3200	4000	8000	18.70	3.20
EN-2002	2"	6400	8000	16000	30.80	5.45
EN-1003	3"	4800	6000	12000	25.85	4.45
EN-1004	4"	6400	8000	16000	33.40	5.70
EN-1006	6"	9600	12000	24000	49.25	9.85

EYE AND EYE (EE)

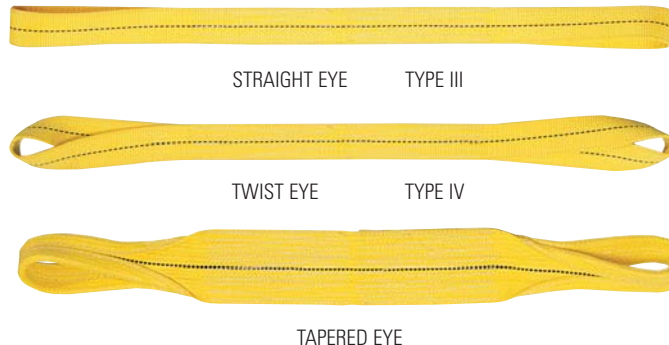

The Safe-Line Eye and Eye Sling works well in choker, vertical and basket hitches. Straight eyes are standard. Twist eyes are better for choker hitches. Eyes are tapered to 1/2 the body width on all slings three inches or wider to facilitate use on crane hooks.

Order by Stock No. and Length	Sling Width Inches	Eye Length Inches	Eye Width Inches	Rated Capacity – Lbs.			User List Price	
				Choker @ 30°	Vertical @ 90°	Basket @ 90°	3 Foot Base Price	Adder Per Foot
EE-1001	1"	10"	1"	800	1000	2000	\$13.20	\$0.85
EE-2001	1"	10"	1"	1600	2000	4000	19.55	1.40
EE-1002	2"	10"	2"	1600	2000	4000	20.90	1.50
EE-2002	2"	10"	2"	3200	4000	8000	33.00	2.80
EE-1003	3"	12"	1 1/2"	2400	3000	6000	33.00	2.30
EE-1004	4"	12"	2"	3200	4000	8000	41.80	2.95
EE-1006	6"	14"	3"	4800	6000	12000	60.50	4.90



WARNING!

DO NOT EXCEED RATED CAPACITIES. REFER TO SLING LOAD CHART ON PAGE 5 FOR RATED CAPACITIES AT OTHER SLING-TO-LOAD ANGLES.

BODY-GUARD (BG)

A WEAR-FLEX ORIGINAL

The Safe-Line Body-Guard Sling is constructed with texturized nylon sleeve body protection and Safe-Line lifting web with texturized nylon "Armor Jacket" protection.

They are the best slings available for heavy duty handling of sharp edges and rough surfaces. The patented sleeve body feature (U.S. Patent #RE 26704) protects all load bearing web from the movement on sharp edges that causes sling abrasion and cutting. This protective nylon sling effectively includes all the best features of Endless, Eye and Eye, Reverse Eye and Dual Eye slings.

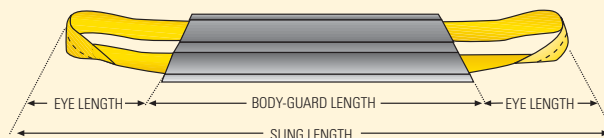
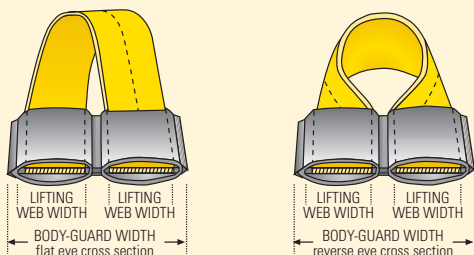

For extra safety, the Body-Guard sleeve is completely adjustable and allows 100% visual inspection of all lifting web.

Order by Stock No. and Length	Lifting Web Width	Eye Length Inches	Rated Capacity – Lbs.			User List Price	
			Choker @ 30°	Vertical @ 90°	Basket @ 90°	3 Foot Base Price	Adder Per Foot
4 1/2" wide free floating Body-Guard Sleeve							
BG-1001	1"	9"	1600	2000	4000	\$21.10	\$4.00
BG-2001	1"	9"	3200	4000	8000	30.50	5.15
6" wide free floating Body-Guard Sleeve							
BG-1002	2"	9"	3200	4000	8000	\$31.55	\$6.25
BG-2002	2"	9"	6400	8000	16000	48.35	9.10

SAFE-LINE PROTECTIVE NYLON SLINGS

TRIANGLE-TRIANGLE (TT)



TYPE II

The Safe-Line Triangle-Triangle Sling is designed for both vertical and basket hitches. It is recommended for use on cranes and hoists having rough hooks. The end fittings are alloy steel.

Order by Stock No. and Length	Body Width Inches	Rated Capacity – Lbs			User List Price	
		Choker @ 30°	Vertical @ 90°	Basket @ 90°	3 Foot Base Price	Adder Per Foot
TT-1002	2"	—	2000	4000	\$48.35	\$1.50
TT-2002	2"	—	4000	8000	60.70	2.80
TT-1003	3"	—	3000	6000	68.60	2.30
TT-1004	4"	—	4000	8000	91.80	2.95
TT-1006	6"	—	6000	12000	138.10	4.90

TRIANGLE-CHOKER (TC)



TYPE I

The Safe-Line Triangle-Choker Sling is designed primarily for choker hitch lifting, but can also be used for vertical as well as basket hitches. The end fittings are alloy steel.

Order by Stock No. and Length	Body Width Inches	Rated Capacity – Lbs			User List Price	
		Choker @ 30°	Vertical @ 90°	Basket @ 90°	3 Foot Base Price	Adder Per Foot
TC-1002	2"	1600	2000	4000	\$57.45	\$1.50
TC-2002	2"	3200	4000	8000	68.05	2.80
TC-1003	3"	2400	3000	6000	79.35	2.30
TC-1004	4"	3200	4000	8000	101.10	2.95
TC-1006	6"	4800	6000	12000	169.10	4.90

ENDLESS-TRIANGLE (ET)



The Safe-Line Endless-Triangle Sling with two standing lines has 100% greater rated lifting capacity than the Triangle-Choker sling with one standing line. The endless design makes a more secure choke. Spreading the legs stabilizes the load for better balance and greater safety. The fitting is alloy steel.

Note: Aluminum fittings are available upon request. Do not use in applications involving alkalis, acids or caustics. Contact factory for pricing.



Order by Stock No. and Length	Body Width Inches	Rated Capacity – Lbs			User List Price	
		Choker @ 30°	Vertical @ 90°	Basket @ 90°	3 Foot Base Price	Adder Per Foot
ET-1002	2"	3200	4000	8000	\$40.45	\$3.20
ET-1003	3"	4800	6000	12000	58.90	4.45
ET-1004	4"	6400	8000	16000	85.35	5.70
ET-1006	6"	9600	12000	24000	147.40	9.85

ALLOY STEEL TRIANGLES AND CHOKERS

WEAR-FLEX TRIANGLES

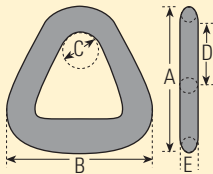

Size	A	B	C	D	E
2"	4 ⁹ / ₁₆	4 ¹ / ₄	1	2 ⁷ / ₈	3 ³ / ₈
3"	5 ¹ / ₄	5 ¹ / ₈	1 ³ / ₄	3 ¹ / ₁₆	3 ³ / ₈
4"	6 ⁵ / ₁₆	6 ³ / ₈	2 ³ / ₈	3 ¹³ / ₁₆	1 ¹ / ₂
6"	8 ⁵ / ₈	8 ³ / ₈	3	5 ¹¹ / ₁₆	5 ⁵ / ₈

E Column = Triangle Thickness

WEAR-FLEX CHOKERS

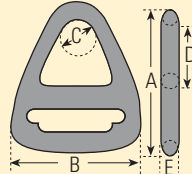

Size	A	B	C	D	E
2"	6 ³ / ₄	5 ⁷ / ₁₆	1	3 ¹ / ₁₆	3 ³ / ₈
3"	8 ¹ / ₄	7 ¹ / ₁₆	1 ³ / ₄	3 ³ / ₄	3 ³ / ₈
4"	9 ³ / ₈	8 ¹ / ₈	2 ³ / ₈	4 ¹ / ₄	1 ¹ / ₂
6"	11 ⁷ / ₈	9 ¹⁵ / ₁₆	3	5 ¹¹ / ₁₆	5 ⁵ / ₈

E Column = Choker Thickness

SAFE-LINE NYLON BRIDLE SLINGS

The Safe-Line Nylon Bridle Sling offers all the advantages of standard Safe-Line Slings. High quality forged fittings are selected to match or exceed the sling rated capacities, with a design factor of 5 to 1.

Compared to other bridle slings, Wear-Flex Safe-Line Bridle Slings are lower in cost, lighter in weight, help absorb shock, do not conduct electricity, and conform to the load without marring or kinking. The endless design also offers longer service life with 100% increased lifting capacity. Standard slings are offered in single or double leg designs.

Special Bridle Sling designs, capacities, and multiple leg slings are offered to meet your particular lifting requirements.

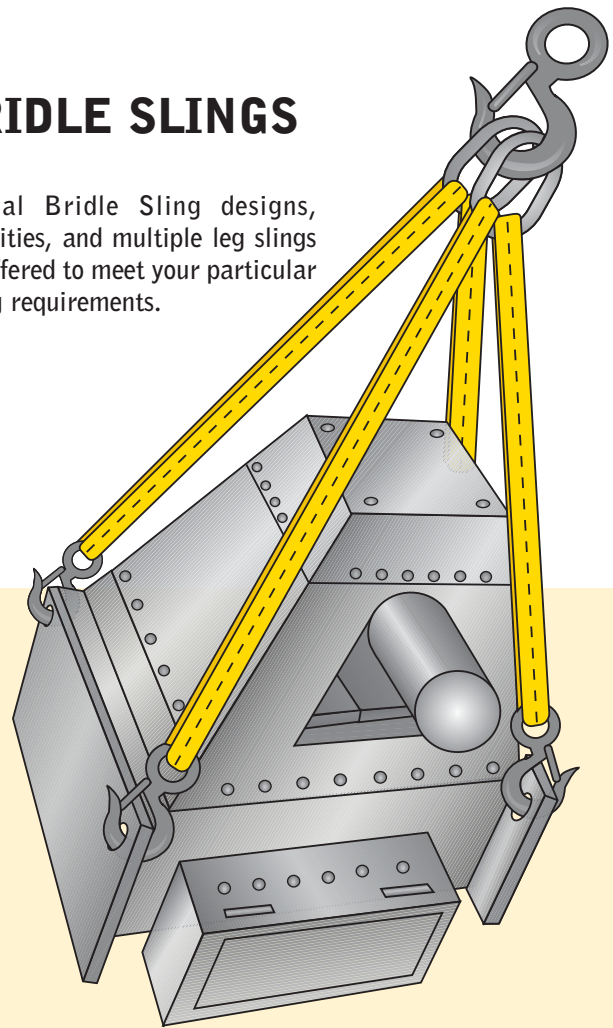

HOW TO ORDER

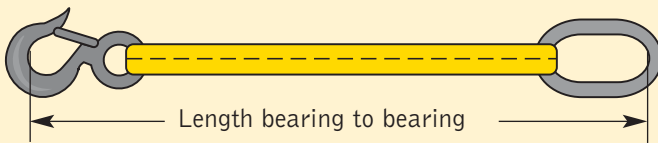

Order by stock number and specify length in feet
3 ft. minimum length

D O S - E N - 2 0 0 1 X 8'

- Leg Configuration
S=Single Leg
D=Double Leg
*T=Triple Leg
*Q=Quadruple
 - Top Fitting
O=Oblong Link
 - Bottom Fitting
O=Oblong Link
S=Sling Hook
E=Fabric Eye
 - Sling Construction
EN=Endless
EE=Eye and Eye
 - Wear-Flex
Web Code
 - Web Width
in Inches
 - Sling
Length
- *Available in 1" wide web only

FORGED FITTINGS SPECIFICATIONS

WELDLESS ALLOY OBLONG MASTER LINKS

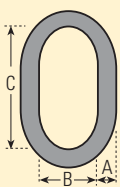

Link Style No.	Dimensions in Inches		
	A Stock Diameter	B Inside Width	C Inside Length
1	1/2"	2.95	4.33
2	5/8"	3.35	4.72
3	3/4"	3.74	5.32
4	1"	4.94	7.09

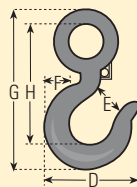

SLING HOOKS – FORGED, QUENCHED AND TEMPERED

Sling Hook Style No.	Dimensions in Inches				
	D Overall Width	E Hook Opening	F Maximum Thickness	G Overall Length	H Inside Length
1	3.18	.86	.98	4.92	3.66
2	4.09	1.06	1.33	6.37	4.68
3	4.92	1.25	1.65	7.87	5.74
4	6.50	1.61	2.08	10.07	7.36

Safety latch assemblies are supplied on all sling hooks.

SAFE-LINE NYLON BRIDLE SLINGS

SAFE-LINE ENDLESS BRIDLE LEG SLINGS

The Safe-Line Endless Bridle Sling is designed to utilize all the features and advantages of an endless sling. It allows fittings to rotate on the endless sling configuration to provide for an infinite number of wear points and longer sling life. The endless sling construction, having two standing lines per leg, gives twice the strength of the conventional eye and eye sling construction. The design is also the most economical, giving you the greatest amount of lifting capacity and value.

Eye and Eye Bridle Slings are available upon request. Contact factory for pricing.

Order by Stock No. and Length	Sling Width Inches	Oblong Master Link No.	Sling Hook No.	Total 3 Ft. Asmby Weight Lbs.	Wt. Per Add'l Foot Lbs.	Rated Capacity Lbs		User List Price	
						Vertical @ 30°	Vertical @ 90°	3 Ft. Base Price	Adder Per Foot
SOS-EN-1001	1"	1	1	2.2	.12	1000	2000	\$40.05	\$1.70
SOS-EN-2001	1"	2	2	4.6	.24	2000	4000	60.30	2.80
SOS-EN-2002	2"	3	3	10.8	.40	4000	8000	89.80	5.45
S00-EN-1001	1"	1	-	2.2	.12	1000	2000	55.75	1.70
S00-EN-2001	1"	2	-	4.2	.24	2000	4000	69.20	2.80
S00-EN-2002	2"	3	-	6.0	.40	4000	8000	81.80	5.45
SSS-EN-1001	1"	-	1	2.2	.12	1000	2000	27.25	1.70
SSS-EN-2001	1"	-	2	5.0	.24	2000	4000	45.70	2.80
SSS-EN-2002	2"	-	3	15.6	.40	4000	8000	105.90	5.45
SS-EN-1001	1"	-	1	1.2	.12	1000	2000	21.80	1.70
SS-EN-2001	1"	-	2	3.1	.24	2000	4000	33.55	2.80
SS-EN-2002	2"	-	3	8.8	.40	4000	8000	67.95	5.45

Order by Stock No. and Length	Sling Width Inches	Oblong Master Link No.	Sling Hook No.	Total 3 Ft. Asmby Weight Lbs.	Wt Per Add'l Foot Lbs.	Rated Capacity Lbs		User List Price	
						Vertical @ 30°	Vertical @ 90°	3 Foot Base Price	Adder Per Foot
DOS-EN-1001	1"	2	1	4.3	.24	2000	4000	\$64.35	\$3.30
DOS-EN-2001	1"	3	2	8.2	.48	4000	8000	87.05	5.50
DOS-EN-2002	2"	4	3	22.2	.80	8000	16000	172.35	10.90
D00-EN-1001	1"	2-1	-	4.3	.24	2000	4000	89.35	3.30
D00-EN-2001	1"	3-2	-	7.4	.48	4000	8000	119.75	5.50
D00-EN-2002	2"	4-3	-	12.5	.80	8000	16000	157.40	10.90
DO-EN-1001	1"	2	-	2.7	.24	2000	4000	49.25	3.30
DO-EN-2001	1"	3	-	4.4	.48	4000	8000	65.20	5.50
DO-EN-2002	2"	4	-	8.8	.80	8000	16000	101.50	10.90

WEBBING REPLACEMENT

To help control costs, Wear-Flex can reweb existing fittings. We do require inspection of the fittings prior to the web replacement to determine if the fittings are reusable. Slings will then be proof tested to twice their rated capacity in compliance with OSHA and ASME B30.9 Standards. A Certificate of Conformance will be supplied upon request.

ENDLESS-SINGLE LEG SLINGS

SOS S00 SSS SS



ENDLESS-DOUBLE LEG SLINGS

DOS D00 DO

