

Operating, Maintenance & Parts Manual

HAND HOIST

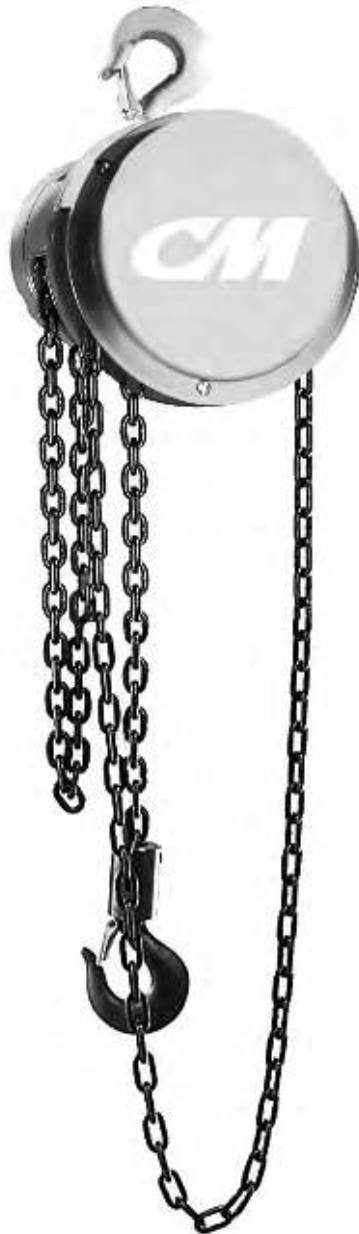

CM CYCLONE HAND HOIST AND LOW HEADROOM TROLLEY HOIST

Rated Loads

Hand Hoists 1/4 through 10 tons. Low Headroom Trolley Hoists: 1/2 through 6 tons

Follow all instructions and warnings for inspecting, maintaining and operating this hoist.

The use of any hoist presents some risk of personal injury or property damage. That risk is greatly increased if proper instructions and warnings are not followed. Before using this hoist, each operator should become thoroughly familiar with all warnings, instructions, and recommendations in this manual. Retain this manual for future reference and use.

Forward this manual to the hoist operator. Failure to operate the equipment as directed in the manual may cause injury.

Before using the hoist, fill in the information below. Model and serial numbers are stamped into the aluminum hoist housing.

Model Number _____

Serial Number _____

Purchase Date _____



Note: When ordering parts, always furnish hoist model and serial number, motor horsepower, voltage, phase, frequency and rated capacity of hoist on which the parts are to be used. For the location of the nearest Authorized Repair Station, Contact CM, (see inside front cover).

LIMITATION OF WARRANTIES, REMEDIES AND DAMAGES

THE WARRANTY STATED BELOW IS GIVEN IN PLACE OF ALL OTHER WARRANTIES, EXPRESS OR IMPLIED, OF MERCHANTABILITY, FITNESS FOR A PARTICULAR PURPOSE, OR OTHERWISE, NO PROMISE OR AFFIRMATION OF FACT MADE BY ANY AGENT OR REPRESENTATIVE OF SELLER SHALL CONSTITUTE A WARRANTY BY SELLER OR GIVE RISE TO ANY LIABILITY OR OBLIGATION.

Seller warrants that on the date of delivery to carrier the goods are free from defects in workmanship and materials.

SELLER'S SOLE OBLIGATION IN THE EVENT OF BREACH OF WARRANTY OR CONTRACT OR FOR NEGLIGENCE OR OTHERWISE WITH RESPECT TO GOODS SOLD SHALL BE EXCLUSIVELY LIMITED TO REPAIR OR REPLACEMENT, F.O.B. SELLER'S POINT OF SHIPMENT, OF ANY PARTS WHICH SELLER DETERMINES TO HAVE BEEN DEFECTIVE or if Seller determines that such repair or replacement is not feasible, to a refund of the purchase price upon return of the goods to Seller.

Any action against Seller for breach of warranty, negligence or otherwise, must be commenced within one year after such cause of action occurs.

NO CLAIM AGAINST SELLER FOR ANY DEFECT IN THE GOODS SHALL BE VALID OR ENFORCEABLE UNLESS BUYER'S WRITTEN NOTICE THEREOF IS RECEIVED BY SELLER WITHIN ONE YEAR FROM THE DATE OF SHIPMENT.

Seller shall not be liable for any damage, injury or loss arising out of the use of the goods if, prior to such damage, injury or loss, such goods are (1) damaged or misused following Seller's delivery to carrier; (2) not maintained, inspected, or used in compliance with applicable law and Seller's written instructions and recommendations; or (3) installed, repaired, altered or modified without compliance with such law, instructions or recommendations.

UNDER NO CIRCUMSTANCES SHALL SELLER BE LIABLE FOR INCIDENTAL OR CONSEQUENTIAL DAMAGES AS THOSE TERMS ARE DEFINED IN SECTION 2-715 OF THE UNIFORM COMMERCIAL CODE.

INDEMNIFICATION AND SAFE OPERATION

Buyer shall comply with and require its employees to comply with directions set forth in instructions and manuals furnished by Seller and shall use and require its employees to follow such instructions and manuals and to use reasonable care in the use and maintenance of the goods. Buyer shall not remove or permit anyone to remove any warning or instruction signs on the goods. In the event of personal injury or damage to property or business arising from the use of the goods, Buyer shall within 48 hours thereafter give Seller written notice of such injury or damage. Buyer shall cooperate with Seller in investigating any such injury or damage and in the defense of any claims arising therefrom.

If Buyer fails to comply with this section or if any injury or damage is caused, in whole or in part, by Buyer's failure to comply with applicable federal or state safety requirements, Buyer shall indemnify and hold Seller harmless against any claims, loss or expense for injury or damage arising from the use of the goods.

 WARNING
Alterations or modifications of equipment and use of non-factory repair parts can lead to dangerous operation and injury.
TO AVOID INJURY:
<ul style="list-style-type: none"> • Do not alter or modify equipment. • Do use only factory provided replacement parts.



COLUMBUS MCKINNON CORPORATION
INDUSTRIAL PRODUCTS DIVISION
140 JOHN JAMES AUDUBON PARKWAY
AMHERST, NEW YORK 14228-1197

CM HOIST PARTS AND SERVICE ARE AVAILABLE IN THE UNITED STATES AND IN CANADA

As a CM Hoist user, you are assured of reliable repair and parts services through a network of Master Parts Depots and Service Centers that are strategically located in the United States and Canada. These facilities have been selected on the basis of their demonstrated ability to handle all parts and repair requirements promptly and efficiently.

Below is a list of the Master Parts Depots in the United States and Canada. To quickly obtain the name of the U.S. Service Center located nearest you, call (800) 888-0985. Fax: (716) 689-5644. In the following list, the Canadian Service Centers are indicated.

UNITED STATES MASTER PARTS DEPOT	CANADIAN SERVICE CENTERS
CALIFORNIA OTTO SYSTEMS, INC. 12010 Bloomfield Ave. Sante Fe Springs, CA 90670 562/462-1612 or 800/596-7392 Fax 562/462-1617 or 7656 Las Positas Road Livemore, CA 94551 925/245-8800 Fax 925/245-8804	ALBERTA BENNETT & EMMOTT, LTD. 18131 118th Avenue Edmonton, Alberta T5S 1M8 403/454-9000 Fax 403/454-8990
COLORADO MATERIALS HANDLING EQUIPMENT CO. 1740 W. 13th Ave. Denver, CO 80204 303/573-5333 or 800/873-5333 Fax 303/893-3854	**COLUMBUS McKINNON, LTD. 10311-174th Street Edmonton, Alberta T5S 1H1 800/263-1997 Fax 403/486-6160
GEORGIA ACE INDUSTRIES, INC. 6295 McDonough Drive Norcross, GA 30093 770/441-0898 or 800/733-2231 Fax 800/628-3648	BRITISH COLUMBIA FLECK BROTHERS, LTD. 4084 McConnel Court Burnaby, British Columbia V5A 3N7
ILLINOIS COLUMBUS McKINNON CHICAGO 10321 Werch Drive Woodridge, IL 60517 877/511-3170 Fax 708/771-7326	MANITOBA KING'S ELECTRIC MOTORS, INC. 633 Tyne Avenue Winnipeg, Manitoba R2L 1J5 204/663-5332 Fax 204/663-4059
INDIANA HORNER ELECTRIC COMPANY, INC. 1521 East Washington Street Indianapolis, IN 46201 317/639-4261 Fax 317/639-4342	NOVA SCOTIA *W & A MOIR 95 Ilsley Ave. Burnside Park, Nova Scotia B3B 1L5 902/468-7720 Fax 902/468-3777
IOWA VMI HOIST & CRANE SERVICES 901 17th Street NE Cedar Rapids, IA 52406 319/365-4662 Fax 319/365-8075	ONTARIO *R & W HOIST REPAIR, LTD. 790 Redwood Square Units 5, 6, & 7 Oakville, Ontario L6L 6N3 905/825-5500 Fax 905/825-5315
KANSAS INDEPENDENT ELECTRIC MACHINERY 4425 Oliver Street Kansas City, KS 66106 913/362-1155 Fax 913/904-3330	*TORONTO ELECTRIC HOIST SALES & SERVICE 9 CoDeco Court North York, Ontario M3A 1A1 416/386-0820 Fax 416/386-0821
LOUISIANA BEERMAN PRECISION, INC. 4206 Howard Ave. New Orleans, LA 70125 504/486-9391 Fax 504/486-7482	*MASLACK SUPPLY, LTD. 488 Falconbridge Road Sudbury, Ontario P3A 4S4 705/566-1270 Fax 705/566-4208
MASSACHUSETTS ABEL DISTRIBUTORS, INC. 50 Parker Street, Unit 2 Newburyport, MA 01950 978/463-0700 Fax 978/463-5200	*COLUMBUS McKINNON, LTD. P.O. Box 1106 10 Brook Road, North Cobourg, Ontario K9A 4W5 905/372-0153 Fax 905/372-3078
NEW JERSEY SHUPPER-BRICKLE EQUIPMENT CO. 2394 Route 130, Suite C Dayton, NJ 08810 732/438-3888 Fax 732/438-3889	QUEBEC *HERCULES SLING & CABLE 3800 TransCanada Highway Pointe-Claire, Quebec H9R 1B1 514/428-5511 Fax 514/428-5555
NEW YORK VOLLAND ELECTRIC EQUIPMENT CO. 75 Innsbruck Drive Buffalo, NY 14227 716/656-9900 Fax 716/656-8898/8899	*LEGER PALANS ET OUTILLAGES, INC. 7995-17th Ave. Montreal, Quebec H1Z 3R2 514/376-3050 Fax 514/376-0657
NORTH CAROLINA TEAM SESCO 2225 Freedom Drive Charlotte, NC 28208 704/372-4832 or 800/487-3726 Fax 704/358-1098	*ARE ALSO MASTER PARTS DEPOTS **MASTER PARTS DEPOT ONLY
OHIO MAZZELLA LIFTING TECHNOLOGIES 21000 Aerospace Parkway Cleveland, OH 44142 440/239-5700 or 800/362-4601 Fax 440/239-5707	
PENNSYLVANIA AMICK ASSOCIATES, INC. 11 Sycamore Street Carnegie, PA 15106-0529 412/429-1212 or 800/445-9456 Fax 412/429-0191	
RAM MOTORS & CONTROLS, INC. 5460-B Pottsville Pike Leesport, PA 19533 610/916-8000 or 877/916-8018 Fax 610/916-7957	
TEXAS ABEL EQUIPMENT CO., INC. 3710 Cavalier Drive Garland, TX 75042 972/272-7706 Fax 972/272-6955	
HYDRAULIC EQUIPMENT SERVICES, INC. 1021 North San Jacinto Street Houston, TX 77002 713/228-9601 Fax 713/228-0931	
WISCONSIN TRESTER HOIST & EQUIPMENT, INC. W136 N4863 Campbell Drive Menomonee Falls, WI 53051 262/790-0700 or 800/234-6098 Fax 262/790-1009	

SAFETY PRECAUTIONS

Each Cyclone Hand Hoist and Low Headroom Trolley Hoist is built in accordance with the specifications contained herein and at the time of manufacture complies with our interpretation of applicable sections of the American Society of Mechanical Engineers Code B30.16 "Overhead Hoist" and the Occupational Safety and Health Act.

The safety laws for elevators and for dumbwaiters may specify construction details that are not necessarily incorporated in CM industrial hoist. We recommend the use of equipment that meets state and national safety codes. Columbus McKinnon Corporation cannot be responsible for applications other than those for which CM equipment is recommended.



Consult Columbus McKinnon Corporation for any usage of Cyclone Hoists that do not involve raising of the load on the lower hook, or usage of Cyclone Hoists in the inverted position. Using hoists, without special precautions, in such applications may cause an accident that could result in injury and/or property damage.

 <h2 style="margin: 0;">WARNING</h2>
<p>Improper operation of a hoist can create a potentially hazardous situation which, if not avoided, could result in <u>death</u> or <u>serious injury</u>. To avoid such a potentially hazardous situation, the operator shall:</p> <ol style="list-style-type: none"> 1. <u>NOT</u> operate a malfunctioning or unusually performing hoist. 2. <u>NOT</u> operate the hoist until you have thoroughly read and understand this manufacturer's Operating, Maintenance and Parts Manual. 3. <u>NOT</u> operate a hoist which has been modified without the manufacturer's approval or certification to be in conformity with applicable OSHA regs. 4. <u>NOT</u> lift or pull more than rated load for the hoist. 5. <u>NOT</u> use damaged hoist or hoist that is <u>Not</u> working properly. 6. <u>NOT</u> use hoist with twisted, kinked, damaged, or worn load chain. 7. <u>NOT</u> use the hoist to lift, support, or transport people. 8. <u>NOT</u> lift loads over people and make sure all personnel remain clear of the supported load. 9. <u>NOT</u> attempt to lengthen the load chain or repair damaged load chain. 10. Protect the hoist's load chain from weld splatter or other damaging contaminants. 11. <u>NOT</u> use load chain as a sling or wrap load chain around load. 12. <u>NOT</u> apply the load to the tip of the hook or to the hook latch. 13. <u>NOT</u> apply load unless load chain is properly seated in the chain wheel(s) or sprocket(s). 14. <u>NOT</u> apply load if bearing prevents equal loading on all load supporting chains. 15. <u>NOT</u> operate beyond the limits of the load chain travel. 16. <u>NOT</u> leave load supported by the hoist unattended unless specific precautions have been taken. 17. <u>NOT</u> allow the chain or hook to be used as an electrical or welding ground. 18. <u>NOT</u> allow the chain or hook to be touched by a live welding electrode. 19. <u>NOT</u> remove or obscure the warnings on the hoist. 20. <u>NOT</u> operate a hoist which has <u>Not</u> been securely attached to a suitable support. 21. <u>NOT</u> operate a hoist unless load slings or other approved single attachments are properly sized and seated in the hook saddle. 22. <u>NOT</u> operate a hoist when it is restricted from forming a straight line from hook to hook in the direction of loading. 23. <u>NOT</u> lift loads that are <u>Not</u> balanced and that the holding action is <u>Not</u> secure, taking up slack carefully. 24. <u>NOT</u> operate a hoist unless all persons are and remain clear of the supported load. 25. Report malfunctions or unusual performances of a hoist, after it has been shut down until repaired. 26. <u>NOT</u> operate a hoist on which the safety placards or decals are missing or illegible. 27. Be familiar with operating controls, procedures, and warnings.

 <h2 style="margin: 0;">CAUTION</h2>
<p>Improper operation of a hoist can create a potentially hazardous situation which, if not avoided, could result in <u>minor</u> or <u>moderate</u> injury. To avoid such a potentially hazardous situation, the operator shall:</p> <ol style="list-style-type: none"> 1. Maintain a firm footing or be otherwise secured when operating the hoist. 2. Check brake function by tensioning the hoist prior to each lift or pulling operation. 3. Use hook latches. Latches are to retain slings, chains, etc. under slack conditions only. 4. Make sure the hook latches are closed and not supporting any parts of the load. 5. Make sure the load is free to move and will clear all obstructions. 6. Avoid swinging the load or hook. 7. Inspect the hoist regularly, replace damaged or worn parts, and keep appropriate records of maintenance. 8. Use the hoist manufacturer's recommended parts when repairing the unit. 9. Lubricate load chain per hoist manufacturer's recommendations. 10. <u>NOT</u> use the hoist load limiting or warning device to measure load. 11. <u>NOT</u> operate except with manual power. 12. <u>NOT</u> permit more than one operator to pull on a single hand chain at the same time. More than one operator is likely to cause hoist overload. 13. <u>NOT</u> allow your attention to be diverted from operating the hoist. 14. <u>NOT</u> allow the hoist to be subjected to sharp contact with other hoists, structures, or objects through misuse. 15. <u>NOT</u> adjust or repair the hoist unless qualified to perform such adjustments or repairs.

Hoist safety is up to you...

WARNING — DO NOT LIFT MORE THAN RATED LOAD.

1 CHOOSE THE RIGHT HOIST FOR THE JOB...

Choose a hoist with the capacity for the job. Know the capacities of your hoists and the weight of your loads. Then match them.

The application, the size and type of load, the attachments to be used and the period of use must also be taken into consideration in selecting the right hoist for the job.

Remember the hoist was designed to ease our burden and carelessness not only endangers the operator, but in many cases, a valuable load.



WARNING — DO NOT OPERATE DAMAGED OR MALFUNCTIONING HOIST. — DO NOT OPERATE WITH TWISTED, KINKED OR DAMAGED CHAIN.

2 INSPECT

All hoists should be visually inspected before use, in addition to regular, periodic maintenance inspections.

Inspect hoists for operations warning notices and legibility.

Deficiencies should be noted and brought to the attention of supervisors. Be sure defective hoists are tagged and taken out of service until repairs are made.



Under no circumstances should you operate a malfunctioning hoist.

Check for gouged, twisted, distorted links and foreign material. Do not operate hoists with twisted, kinked or damaged chain links.

Load chain should be properly lubricated.

Hooks that are bent, worn or whose openings are enlarged beyond nominal throat opening should not be used. If latch does not engage throat opening of hook, hoist should be taken out of service.

Chains should be checked for deposits of foreign material which may be carried into the hoist mechanism.

Check brake for evidence of slippage under load.



WARNING — DO NOT PULL AT AN ANGLE. BE SURE HOIST AND LOAD ARE IN A STRAIGHT LINE. — DO NOT USE LOAD CHAIN AS A SLING.

3 USE HOIST PROPERLY

Be sure hoist is solidly held in the uppermost part of the support hook etc.



Be sure hoist and load are in a straight line. Do not pull at an angle.



Be sure load is hooked securely. Do not tip load the hook. Do not load hook latch. Hook latch is to prevent detachment of load under slack chain conditions only.



Do not operate with hoist head resting against any object. Lift the load gently. Do not jerk it.

WARNING — DO NOT LIFT PEOPLE OR LOADS OVER PEOPLE.

4 PRACTICE CAUTION ALWAYS

Do not lift co-workers with a hoist.

Make sure everyone is clear of the load when you lift.

Do not remove or obscure operational warning notices

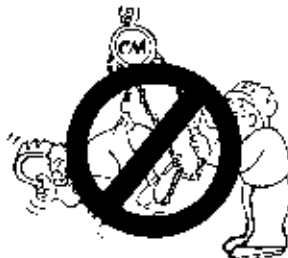

5 OPERATOR SERVICE

CLEANING
Hoists should be kept clean and free of dust, dirt, moisture, etc., which will in any way affect the operator or safety of the equipment.

LUBRICATION
Chain should be properly lubricated.

AFTER REPAIRS
Carefully operate the hoist before returning it to full service



VIOLATIONS OF ANY OF THE WARNINGS LISTED MAY RESULT IN SERIOUS PERSONAL INJURY TO THE OPERATOR OR NEARBY PERSONNEL BY NATURE OF RELEASED LOAD OR BROKEN HOIST COMPONENTS.

FOREWORD

This manual contains important information to help you properly install, operate and maintain your Cyclone Hoist for maximum performance, economy and safety.

Please study its contents thoroughly before putting your hoist into operation. By practicing correct operating procedures and by carrying out the recommended preventive maintenance suggestions, you will experience long, dependable and safe service.

After you have completely familiarized yourself with the contents of this manual, we recommend that you carefully file it for future reference.

The information herein is directed to the proper use, care and maintenance of the Cyclone Hoist and does not comprise a handbook on the broad subject of rigging. Rigging can be defined as the process of lifting and moving heavy loads using hoists and other information, we recommended consulting a standard textbook on the subject.

A copy of this manual is packed with each Cyclone Hand and Low Headroom Trolley Hoist.

TABLE OF CONTENTS

SAFETY PRECAUTIONS	PAGE
Master Parts Depots	i
Do's and Do Not'sii
Hoist Safety is Up To Youiii
Foreward1
GENERAL INFORMATION	
Specifications2
Hooks3
CM Repair/Replacement Policy3
OPERATION AND INSTALLATION	
Unpacking Information3
Operating Instructions3
Trolley Installation4
OPERATING AND SAFETY PROCEDURES	
INSPECTION	
Inspection5
Frequent Inspections6
Periodic Inspections6
Hook Inspection7
Load Chain7
Hand Chain8
MAINTENANCE	
Lubrication8
Recommended Spare Parts8
Exterior Finish8
Disassembly9
Assembly9
Reeving11-14
Cutting Chains14
Testing14
Troubleshooting15
PARTS LIST	
Ordering Information16
Cyclone Hand Hoist Parts List17-22
Cyclone Low Headroom Trolley Hoist Parts List23-27

LIST OF TABLES		PAGE
1	Frequent Inspection6
2	Periodic Inspection6
3	Min. Hoist Loads & Pulls10

LIST OF ILLUSTRATIONS		
1	Cyclone Available Models2
2	Cyclone Low Headroom Trolley Hoist3
3	Hook Styles Available3
4	Raising and Lowering Hook3
5	Trolley Spacer Arrangement4
6	Cyclone Hand Hoist5
7	Latch Hook Opening7
8	Latchlok Hook Opening7
9	Gaging Load Chain Wear7
10	Brake Assembly9
11	Load Limiter Assembly9
12	Load Limiter Calibration10
13	Bearing Retainer Screws10
14	Hoist Hanger10
15	Hook Mounting11
16	Reeving ¼-½-1 Ton Hoists11
17	Reeving 1½-10 Ton Hoists12
18	Reeving 3-4 Ton Hoists12
19	Reeving 5-6 Ton Hoists13
20	Reeving 8 Ton Hoists13
21	Reeving 10 Ton Hoists14
22	Cutting Chain by Nicking14
23	Cutting Chain with Bolt Cutter14
24	Ordering Information16
25	Cyclone Hand Hoist Exploded View21-22
26	Cyclone Low Headroom Trolley Hoist Parts List Drawing23-25

GENERAL INFORMATION

SPECIFICATIONS

CM Cyclone Hand Hoists

The Cyclone Hand Hoist is a highly versatile tool that can be used to lift loads. The hoist has aluminum frame, handwheel, handwheel cover and gear cover to provide dependable strength at minimum weight. The internal gears are made of high grade, heat treated steel. Shielded ball bearings are used at each rotating point in the mechanism. Latch type, heat treated, forged steel upper and lower hooks are standard. The load chain is strong and durable Hoistaloy®. A pawl and ratchet, dry-operating, Weston-type friction brake supplies very positive load control and will suspend the load at any point. A Load Limiter is provided on every unit. As a result, the application of an excessive overload disengages the driving handwheel and prevents hoisting. Note that the Load Limiter is not intended for use as a scaling device. Removal of the excess load automatically restores normal hoisting action (see Figure 1 for specifications of available models).

Cyclone Low Headroom Trolley Hoists

The Cyclone Low Headroom Trolley Hoists (Figure 2, page 3) are a combination of the Cyclone Hand Hoist built integral with a rugged trolley to provide better headroom than that obtained with the standard hoist and trolley. The basic hoist is similar to the Cyclone Hand Hoist except the frame, aluminum on the 1/2 through 3 ton units and cast iron on the 4 through 6 ton units, which is designed to provide low headroom and attachment to the trolley. The trolley has a rugged frame, cast iron on the 1/2 through 1 ton units, and steel plates on the 1 1/2 through 6 ton units. Crowned tread, flanged trackwheels are provided to minimize rolling friction. Hardened, pressed steel ball bearing wheels are used on the 1/2 and 1 ton units. Hardened, cast iron wheels with Timken bearings are used on the 1 1/2 through 6 ton units. Trolleys are adjustable for operation on various American standard beams and the 1 1/2 through 6 ton units are available in a geared type trolley.



Maximum Capacity (Tons)	¼	½	1	1½	2	3	4	5	6	8	10
Code	4621	4622	4624	4625	4626	4627	4628	4629	4630	4631	4632
DC Code	64621	64622	64624	64625	64626	64627	64628	64629	64630	64631	64632
Standard Lift (Ft.)	8	8	8	8	8	8	8	8	8	8	8
Net Weight (Lbs.)	33	33	36	59	60	84	91	122	127	207	219
Shipping Weight (Lbs.)	35	35	38	63	64	91	98	129	134	237	244
Shortest Distance Between Hooks (In.)	12 7/8	12 7/8	14	17 5/16	17 5/16	21 ½	21 ½	24 ¼	25 ¼	35 ½	35 ½
Chain Overhauled to Lift Load 1 Foot (Ft.)	22 ½	22 ½	30	40 ½	52	81	104	156	156	208	260
Lift Load 1 Foot (Ft.) Chain Pull to Lift Full Load (Lbs.)	23	46	69	80	83	85	88	75	90	89	95

Figure 1. Cyclone Hand Hoist, Available Models

With Plain Trolley

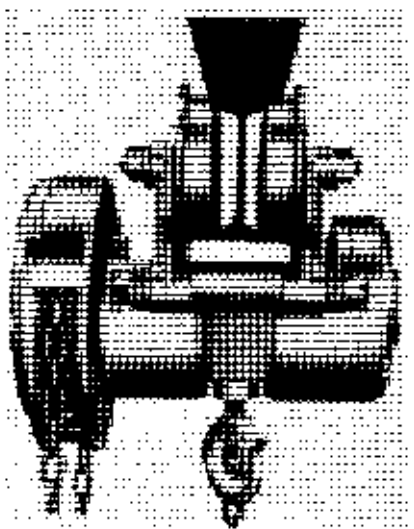

With Geared Trolley

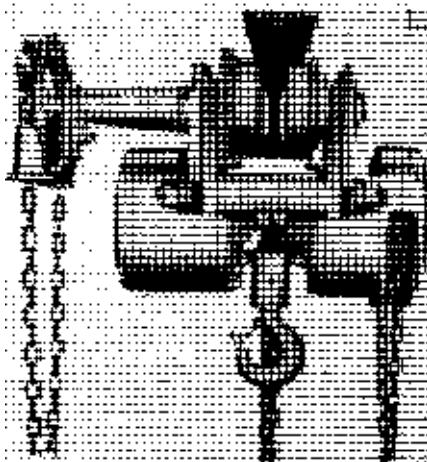

Figure 2.

Cyclone Low Headroom Trolleys Hoists

HOOKS

Type of hooks supplied on the Cyclone Hoists are shown in Figure 3.

Latch Type Hook
Standard

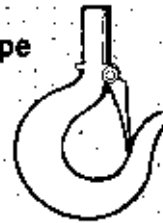

*Latchlok Type Hook (Optional) — upper and lower



*Also available in klt form for hoists now in use.

CM REPAIR/REPLACEMENT POLICY

All Columbus McKinnon (CM) Cyclone Hand Hoists and Low Headroom Trolley Hoists are thoroughly inspected and performance tested prior to shipment. If any properly maintained Cyclone Hoist develops a performance problem due to a material or workmanship defect, as verified by CM or an authorized service station, repair or replacement of the unit will be made to the original purchaser without charge. This repair/replacement policy applies only to Cyclone Hoists installed, maintained and operated as outlined in this manual, and specifically excludes parts subject to normal wear, abuse, improper installation, improper or inadequate maintenance, hostile environmental effects, and unauthorized repairs/modifications.

We reserve the right to change materials or design if in our opinion, such changes will improve our product. Abuse, repair by an unauthorized person, or use of non-CM replacement parts voids the guarantee and could lead to dangerous operation. For full Terms of Sale, see Sales Order Acknowledgement. Also, refer to the back cover for Limitations of Warranties, Remedies and Damages and, Indemnification and Safe Operation.

OPERATION AND INSTALLATION

UNPACKING INFORMATION

After removing the hoist from the carton, check to be sure there has been no damage in shipment. Before cutting the cord ties on multiple-reeved units, be sure that all strands of chain are straight with no twist (due to a capsized hook block). If length of lift is to be modified, follow disassembly and assembly instructions for correct procedure.

OPERATING INSTRUCTIONS

After mounting and before placing in service, check the hoist for proper operation. On multi-reeved units, be sure that all strands of chain are straight with no twist (due to a capsized hook block).

The CM Cyclone Hand Hoist must always be rigged to lift in a straight line from hook to hook (see Figure 4). The hoist must always be free to swivel on the upper hook. Under no condition should the hoist be allowed to bear on any support when in use as this would cause bending of the hook or frame and damage the unit.

To Lower Hook
Pull on This
Part of
Hand Chain



To Raise Hook
Pull on This
Part of
Hand Chain



Figure 4. Raising and Lowering Hook

TROLLEY INSTALLATION

! WARNING

Operating the trolley hoist on a beam that has no rail stops may allow the trolley hoist to fall off the end of the beam.

To Avoid Injury:

Install rail stops at each end of the beam on which the trolley hoist is to operate.

The railstops must be positioned so as to not exert impact force on the hoist portion of the unit or the trolley wheels. They must contact the ends of the trolley side frames.

Due to the variations in beam flange widths, it is suggested that the beam flange width be measured to determine the exact distribution of spacer washers. The distance between trackwheel flanges (dimension "X") should be 1/8 to 3/16 inch greater than the beam flange width for straight runway beams, and 3/16 to 1/4 inch greater than the beam flange width if runway system includes sharp curves. Also, the use of other than CM supplied washers may result in trackwheel to beam flange variations and thus Figure 5 will not apply.

Assemble the trolley on the beam by sliding one side out far enough to allow the wheels to clear the beam flange. Draw side frames together and tighten nuts securely (do not over tighten) and then install the cotter pins.

! WARNING

If washer spacing recommendations are not followed, trolley hoist may fall from beam.

To Avoid Injury:

Measure the actual beam flange on which the trolley hoist is to operate and use figure 5 to determine the arrangement of the spacer washers for that flange width.

Immediately after installation, operate trolley with a capacity load over the entire length of runway or monorail system to be sure that all adjustments and operations are satisfactory.

When applying a load, it should be directly under the trolley. Avoid off center loading of any kind. Side loading may spread trolley side frames.

On systems with curves, the edges of the rail at the curved sections should be lightly lubricated with grease.

! WARNING

An excessively worn beam flange may fail and allow the trolley hoist to fall from the beam.

To Avoid Injury:

Periodically inspect the beam flange for wear. Replace beam if flange is worn.

S-Beam		Number of Spacers																
Size	Flange	1/2-1 Ton				1 1/2-2 Ton				3 Ton				4-5-6 Ton				
		A	B	C	D	A	B	C	D	A	B	C	D	A	B	C	D	
4"x 7.7	2-5/8	4	0	0	4													
4"x 9.5	2-3/4	4	0	1	3													
5"x 10.0	3	2	2	2	2													
5"x 14.7	3-1/4	0	4	3	1													
6"x 12.5	3-3/8	10	0	0	10	13	0	0	13									
6"x 17.2	3-5/8	9	1	2	8	12	1	1	12									
7"x 15.3	3-5/8	8	2	2	8	11	0	0	11	11	0	0	11					
7"x 20.0	3-7/8	7	3	3	7	10	1	1	10	10	1	1	10					
8"x 18.4	4	6	4	4	6	9	2	2	9	9	2	2	9	18	0	0	18	
8"x 23.0	4-1/8	5	5	5	5	8	3	3	8	8	3	3	8	17	1	1	17	
10"x 25.4	4-5/8	2	8	8	2	5	6	6	5	5	6	6	5	14	4	4	14	
10"x 35.0	5	0	10	10	0	3	8	8	3	3	8	8	3	12	6	6	12	
12"x 31.8	5	0	10	10	0	3	8	8	3	3	8	8	3	12	6	6	12	
12"x 35.0	5-1/8					3	8	9	2	3	8	9	2	12	6	7	11	
12"x 40.8	5-1/4					2	9	10	1	2	9	10	1	11	7	8	10	
12"x 50.0	5-1/2					0	11	11	0	0	11	11	0	9	9	9	9	
15"x 42.9	5-1/2					0	11	11	0	0	11	11	0	9	9	9	9	
15"x 50.0	5-5/8													8	10	10	8	
18"x 54.7	6													6	12	12	6	
18"x 70.0	6-1/4													4	14	13	5	
20"x 65.4	6-1/4													4	14	13	5	
20"x 75.0	6-3/8													3	15	14	4	
24"x 79.9	7													0	18	18	0	

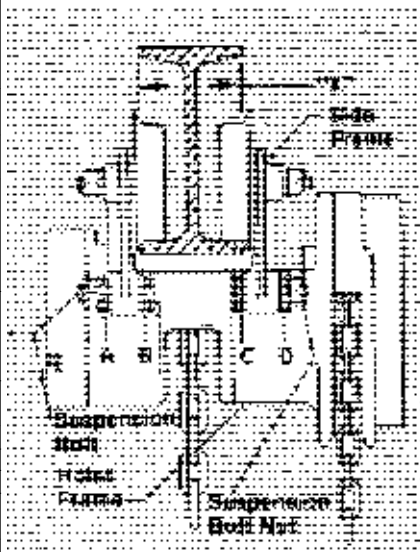

FIGURE 5. Trolley Spacer Arrangement

OPERATING AND SAFETY PROCEDURES

For safety precautions and a list of do's and do not's for safe operation of hoists, refer to page ii.

The Cyclone Hand Hoist (see Figure 6) must always be rigged to lift in a straight line from hook to hook. The hoist must always be free to swivel on the upper hook. Under no condition should the hoist frame or hanger be allowed to bear on any support when in use as this would cause bending of the hook or frame and damage the unit.

When preparing to lift or move a load, be sure that the attachments to both hooks are firmly seated in the saddles of the hooks. Avoid off center loading of any kind especially loading on the point of the hook.

When lifting, raise the load only enough to clear the floor or support, and check to be sure brake will hold load and that attachments to the load are firmly seated. Continue the lift only after you are assured the load is free of all obstructions.

Do not load beyond the rated capacity of the hoist. Overloading can cause immediate failure of some load carrying part or result in damage causing failure at less than rated capacity. When in doubt, use the next larger capacity of Cyclone Hoist.

Do not wrap load chain around the load or bring the load in contact with the hoist. Doing this will result in the loss of the swivel effect of the hook which could cause twisted chain and a jammed lift-wheel. The chain could be damaged at the hook.

Rail stops must be installed for all trolleys operating on open end beams. These stops must be positioned to exert impact force on the trolley side frames only.

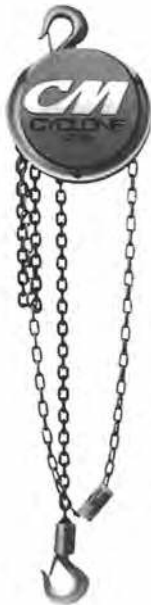

FIGURE 6. Cyclone Hand Hoist

Do not use this or any other overhead materials handling equipment for lifting persons.

Stand clear of all loads and avoid moving a load over the heads of any people. Warn any people of your intention to move a load in their area.

Do not leave the load suspended in the air unattended.

Do not lower the hook to a point where the chain becomes taut between the liftwheel and loose end screw. (See Troubleshooting, Item 5C).

The Cyclone Hand Hoist and Cyclone Low Headroom Trolley Hoist have been designed for manual operation only.



WARNING

Power operation may result in structural damage or premature wear that may cause a part to break and allow the load to fall.

To Avoid Injury:

Operate Cyclone Hand and Trolley Hoists using hand power only.

INSPECTION

To maintain continuous and satisfactory operation, a regular inspection procedure must be initiated to replace worn or damaged parts before they become unsafe. Inspection intervals must be determined by the individual application and are based on the type of service to which your hoist will be subjected and the degree of exposure to wear, deterioration or malfunction of the critical components.

The type of service to which the hoist is subjected can be classified as "Normal", "Heavy" and "Severe".

Normal Service: involves operation with randomly distributed loads within the rated load limit, or uniform loads less than 65% of rated load for not more than 25% of the time.

Heavy Service: involves operating the hoist within rated load limit which exceeds normal service.

Severe Service: is normal or heavy service with abnormal operating conditions.

Following are the recommended, minimum intervals of inspection. When the unit is subjected to extra heavy usage or dusty, gritty, moist, or other adverse atmospheric conditions, shorter time intervals must be assigned. During the Periodic Inspection, inspection must be made of all parts for unusual wear, corrosion effect or damage in addition to those specifically mentioned.

Before working on the hoist, review the disassembly and assembly information on pages 9 through 14.

Minimum Inspection Schedule

Frequent Inspections: These inspections are visual examinations by the operator or other designated personnel. Records of such inspections are not required. The frequent inspections are to be performed monthly for normal service, weekly to monthly for heavy service, and daily to weekly for severe service and they should include those items listed in Table 1.

Periodic Inspections: These inspections are visual inspections of external conditions by an appointed person. Records of periodic inspections are to

be kept to provide the basis for continuing evaluation of the condition of the hoist.

Periodic inspections are to be performed yearly for normal service, semi-annually for heavy service and quarterly for severe service and they are to include those items listed in Table 2.

Any parts that are deemed unserviceable are to be replaced with new parts before the unit is returned to service. It is very important that the unserviceable parts be destroyed and properly disposed of to prevent their possible future use as a repair item.

Table 1 Minimum Frequency Inspections







TYPE OF SERVICE			ITEM
Normal	Heavy	Severe	
 Monthly	 Weekly to Monthly	 Daily to Weekly	a) Brake for evidence of slippage. b) Hooks for damage, cracks or excessive throat opening, latch engagement and latch operation - see page 7. c) Inspect load chain for adequate lubrication, signs of wear, damaged links or foreign matter - see page 7. d) Inspect reeving of the load chain to make sure it is proper - see page 11.

Table 2 Minimum Periodic Inspections

TYPE OF SERVICE			ITEM
Normal	Heavy	Severe	
 Yearly	 Twice a Year	 Every 3 Months	a) Frequent inspections per Table 1. b) External evidence of loose bolts or nuts. c) External evidence of worn, corroded, cracked or distorted hook blocks, suspension bolts, gears, pins, bearings, hand chain wheel, frames, hoist hanger, load chain guide, hook block pin on 1/4 thru 2 ton units, dead end pin on 3, 4, 8 and 10 ton units, and dead end screw on 5 and 6 ton units. d) External evidence of damage to hooks, hook nuts or collars and hook nut or collar pins. e) External evidence of damage or excessive wear of the pockets of the liftwheel, handwheel, hook block sheaves and hanger sheaves. f) External evidence of worn, glazed or oil contaminated friction discs, scoring of handwheel hub, ratchet, and friction hub. g) External evidence of worn pawl and ratchet teeth; corroded, stretched or broken pawl spring. h) Supporting structure and trolley, if used, for continued ability to support the imposed loads. i) Inspect trolley wheels for external wear on the tread and flange, and for wear on the internal bearing as evidenced by looseness on the stud. j) Warning label and tube for absence or illegibility. k) Check for proper connections at dead end and loose end of load chain. l) Load Limiter components for corrosion.

 **WARNING**

Any deficiencies are to be corrected before returning the hoist to service. Operating a hoist with worn or damaged parts or a malfunctioning hoist may result in serious personal injury to the operator, nearby personnel and/or property damage.

Also, the external conditions may show the need for disassembly to permit a more detailed inspection which, in turn, may require the use of nondestructive type testing.

PREVENTIVE MAINTENANCE

In addition to the above inspection procedure, a preventive maintenance program should be established to prolong the useful life of the hoist and maintain its reliability and continued safe use. The program should include the periodic inspections with particular attention being paid to the lubrication of various components using the recommended lubricants.

HOOK INSPECTION

Hooks damaged from chemicals, deformation or cracks, or that have more than a 10 degree twist from the plane of the unbent hook or excessive opening or seat wear must be replaced.

Also, on latch type hooks, hooks that are opened and allow the latch to disengage the tip, must be replaced.

Any hook that is twisted or has excessive throat opening indicates abuse or overloading of the unit. Other load sustaining components of the hoist should be inspected for damage.

Check to assure latch is not damaged or bent and that it operates properly with sufficient spring pressure to keep the latch tightly against the tip of the hook and allow the latch to spring back to the tip when released. If the latch does not operate properly, it should be replaced.

The charts below (Figures 7 and 8) should be used to determine when the hook must be replaced.

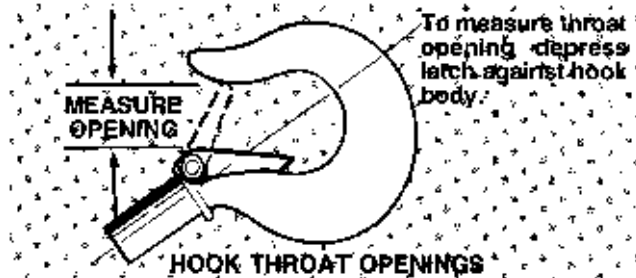

HOOK THROAT OPENINGS

Hoist Capacity (Tons)	Opening (Inches) - Replace Hook When Opening Is Greater Than:
1/4 & 1/2	1 3/16
1	1 1/8
1 1/2 & 2	1 1/2
3, 4 & 5	1 7/8
6	2
8	2 1/4
10	2 5/8

FIGURE 7. Latch Hook Opening

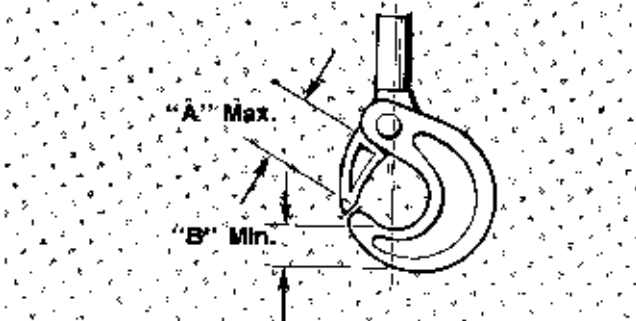

HOOK THROAT OPENINGS AND SEAT WEAR

Hoist Capacity (Tons)	Replace Hook When Opening or Seat Are:	
	"A" Max.	"B" Min.
1/4, 1/2 & 1	1 31/64	2 1/32
1 1/2, 2, 3 & 4	1 59/64	2 7/32
5 & 6	2 1/2	1 1/8
8 & 10	2 15/16	1 11/32

FIGURE 8. Latchlok Hook Opening

LOAD CHAIN

Cleaning and Inspection

First clean the load chain with a non-acid or non-caustic type solvent, then slack the chain and make a link-by-link inspection for nicks, gouges, twisted links and excessive wear or stretching. Worn chain should be gaged throughout its entire length and replaced if beyond serviceable limits. Also, these chains are specially heat treated and hardened and should never be repaired.

! WARNING

Using other than a CM supplied load chain may cause the chain to jam and this, in turn may break the chain and allow the load to drop.

To Avoid Injury:

Use only Hoistaloy® load chain in the Cyclone Hand and Low Headroom Trolley Hoists.

Gaging Load Chain Wear

To determine if the load chain should be continued in service, check gage lengths as indicated in Figure 9. Chain worn beyond length indicated, nicked, gouged or twisted should be replaced before returning the hoist to service. Chain should be clean, free of twists and pulled taut before measuring. To aid in checking gage length, CM can provide a chain gage. This can be obtained by ordering chain gage part number 3191.

! WARNING

Worn load chain may break suddenly without visual deformation.

To Avoid Injury:

Never use load chain for any other purposes such as slings or tow chains. Cut worn chain into short lengths to eliminate use after disposal.

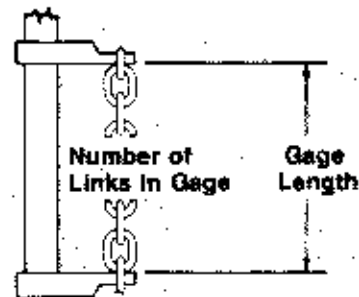

Hoist Capacity (Tons)	Dia. Chain Stock (Inches)	No. of Links To Gage	Max. Gage Length Allowable Used Chain (Inches)
1/4 - 1	250	19	14 - 3/4
1	281	21	18 - 3/4
1 1/2 to 10	375	19	20 - 3/4
Hand Chain	234	13	14 - 1/2

FIGURE 9. Gaging Load Chain Wear

Note that worn chain can be an indication of worn hoist components. For this reason, the hoists chain guide, hook blocks and liftwheel should be examined for wear and replaced as necessary when replacing worn chain.

The proper installation of the load chain is covered in the section on reeving, (see Pages 11 through 14.

HAND CHAIN

Hand chain should be cleaned, inspected and gaged in the same manner as load chain. It is not hardened and can be cut with a hacksaw.

The hoist hand chain contains one unwelded connecting link. This link can be placed in a vise and twisted open to facilitate changing chain length. Additional connecting links can be made by cutting the weld side of a standard link.

Care must be taken to assure that there is no twist in the hand chain loop.

MAINTENANCE

LUBRICATION

 WARNING
The lubricants used in and recommended for the Cyclone Hand and Trolley Hoists may contain hazardous materials that mandate specific handling and disposal procedures.
To Avoid Contact and Contamination: Handle and dispose of lubricants only as directed in applicable material safety data sheets and in accordance with applicable local, state and federal regulations.

NOTE: To assure extra long life and top performance, be sure to lubricate the various parts of Cyclone Hoist using the lubricants specified below. If desired, these lubricants may be purchased from CM. Refer to page 19 for information on ordering the lubricants.

LOAD CHAIN

Lubricate chain with a light coat of Lubriplate®, Bar and Chain Oil (Fiske Bros. Refining Co.) or equal lubricant. Be sure the lubricant reaches the bearing surface between the links. Remove excess oil from the chain.

 WARNING
Used motor oils contain known carcinogenic materials.
To Avoid Health Problems: Never use used motor oils as a chain lubricant. Only use Lubriplate® Bar and Chain Oil 10-R as a lubricant for the load chain.

The hoist normally requires no additional lubrication except when a unit has been disassembled for cleaning or repairs (see page 9).

NOTE: The brake is designed to operate dry. Do not use any grease or lubricant on the braking surfaces. On reassembly when lubricating parts adjacent to the brake, do not use an excessive amount of lubricant which could seep onto the brake surfaces.

Load Limiter. Place a small amount of stay-put lubricant such as Moly-Duolube Style 69 (Hercules Packing Co.) on load limiter handwheel threads. Do not allow lubricant to contact brake surfaces or friction surfaces of load limiter.

Gears. Lubricate the gears with Texaco Novatex #2 or equal, 3 ounces for the 1/4-1 ton units and 4 ounces for the 1 1/2-10 ton units. Spread some grease on gear teeth, place the balance in gear housing in contact with the gears.

Geared Trolleys. Upon installation and once a month lubricate trackwheel gears and pinion with Texaco Novatex #2 or an equivalent heavy cup grease or graphite grease.

Brake. The brake parts should be thoroughly cleaned (by wiping with a cloth - not by washing with a solvent) and inspected for wear or scoring. The friction surfaces of the handwheel, ratchet and friction hub must be smooth and free from any score marks. When friction washers are visibly worn to a thickness of 0.100 inches or less, scored excessively, or coated with foreign matter, replace with new washers. Keep washers and brake surfaces clean and dry.

RECOMMENDED SPARE PARTS. Refer to page 20 for the list of recommended spare parts.

EXTERIOR FINISH

The exterior surfaces of the hoist and trolleys have a durable, scratch resistant baked powder coating. Normally, the exterior surfaces can be cleaned by wiping with a cloth. However, if the finish is damaged, compatible touch-up paint can be purchased from CM. Refer to page 19 for information on ordering the paint.

DISASSEMBLY

Care must be exercised in disassembly of the hoist to assure proper assembly. The following pins have tapered splines and can only be removed by tapping on the end opposite the splined grooves.

Lower Hook Block, Upper Hook Collar and Dead End Pins

When removing or installing the Lower Hook Block Pins (646-29J or 646-129J) on the 1/4 thru 2 ton units, the Upper Collar Pins (646-1E or 646-101E) on the 1/4 thru 2 ton units and the Dead End Pins (646-259) on the 3, 4, 8 and 10 ton units, care must be taken so as to prevent damaging the pin and/or the part into which the pin is driven. These pins are tapered groove pins and as a result, they can only be removed and installed in one direction. To remove the pin, a drift and hammer (or slow acting press) are required. For the lower hook block pins, a V-block will also be necessary. The drift should be the same diameter as the pin (5/16" diameter for the 1/4 thru 1 ton units and 7/16" diameter for the 1 1/2, 2, 3, 4, 8 and 10 ton units) and it should be placed on the small end of the pin. The small end of the pin is the end opposite the end on which the 3 grooves are visible. Place the drift on the small end of the pin and drive the pin out using a hammer or slow acting press. When removing the pin from the lower hook block, the hook block should be placed in a V-block.

To re-install the pin, the parts must be arranged the same as they were when the pin was removed. To do this, use the small end of the pin as a gauge. After it is determined which end of the hole is the largest, arrange the parts so that the large holes are aligned and insert the small end of the pin into the hole. Push the pin in by hand until it stops and then use a hammer or slow acting press to drive the pin into position so that the end of the pin is flush with the outside surface of the hook block body, upper hook collar or hoist hanger.

	WARNING
Using other than the CM supplied, high strength pins may cause the pin to break and allow the hoist and/or load to fall.	
To Avoid Injury:	
Use only the special high strength pin as supplied by CM.	

ASSEMBLY

Consideration must be given to the following when assembling the hoist:

Brake. Assemble the brake components per Figure 10. Check the ratchet to be sure the bushing is flush with or below the surface on both sides. When installed, the teeth must face as shown in Figure 10 and engage the pawl. Do not lubricate. The brake operates dry.

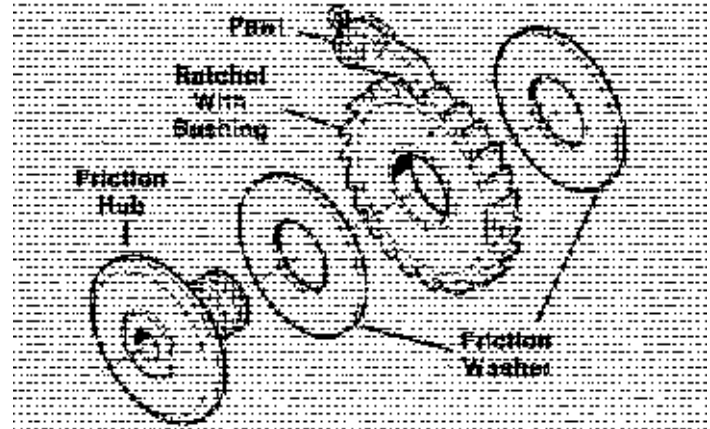

FIGURE 10. Brake Assembly

Load Limiter. Place a small amount of stay-put lubricant such as Moly-Duolube Style 69 (Hercules Packing Co.) on Load Limiter handwheel threads to lubricate the friction hub at assembly. Do not allow lubricant to contact brake surfaces or friction surfaces of Load Limiter.

The handwheel shaft nut and washer must tighten against the friction hub, not the Load Limiter (see Figure 11). the Load Limiter must be free to revolve slightly on the friction hub. If the Load Limiter is disassembled, it must be recalibrated before being placed in service.

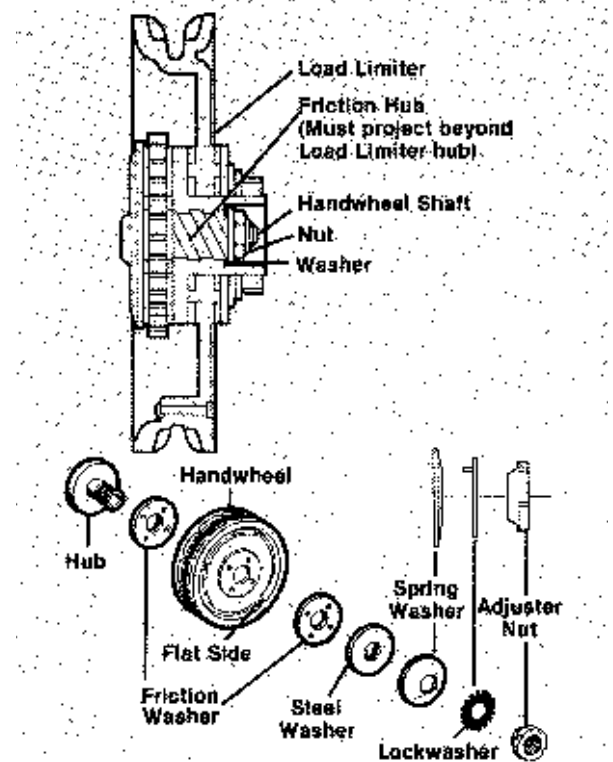

FIGURE 11. Load Limiter Assembly

Components must be assembled in the order shown with the friction washers seated on the handwheel projections. Handwheel, spring washer, lockwasher and nut must face as shown.

Tighten the adjuster nut hand tight, then turn clockwise one notch. A NOTCH is turning the nut sufficient to bring a slot in the nut and a tang of the lockwasher in line. The next notch brings a different slot and tang in line.

Do not bend the lockwasher tang at this time.

The Load Limiter *must* be calibrated after assembly.

Calibration. Install the Load Limiter (see Figure 11) and hand chain but not the handwheel cover. Mount the hoist where a load greater than that shown in Table 3 can be applied. Connect a straight spring scale to the hand chain so that a pull can be applied in the hoisting direction.

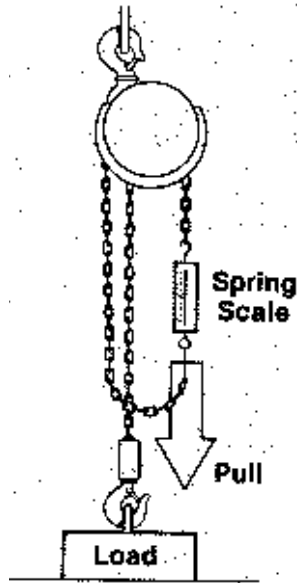

FIGURE 12. Load Limiter Calibration

Table 3 Minimum Hoist Loads & Pull

Hoist Capacity (Tons)	Minimum Load (Pounds)	Average Pull To Slip Load Limiter (Pounds)
1/4	650	33
1/2	1,300	67
1	2,600	100
1 1/2	3,900	113
2	5,200	117
3	7,800	118
4	10,400	121
5	13,000	106
6	15,600	127
8	20,800	133
10	26,000	139

With the load chain taut, apply a steady pull to the scale to slip the handwheel one revolution (approx. 2 ft. of hand chain travel - see Figure 12). Record several pull values and obtain the average. Disregard the initial "break free" pull - use only values obtained after the handwheel has started to slip. When properly adjusted, the average pull should be as indicated in Table 3.

If the average pull is low, turn the adjuster nut one notch clockwise and repeat the pull operation. Do this until the correct value is obtained, then bend the lockwasher tang into the locknut notch. Load Limiter is now ready for service.

If the handwheel does not slip or the pull is too high, back off the adjuster nut and start over. After the proper calibration is obtained, install the handwheel cover.

Bearing Retainer Screws. Whenever the bearing retainer screws have been removed and replaced, they must be locked in place by prick punching the head (see Figure 13). Always use new spots for locking.

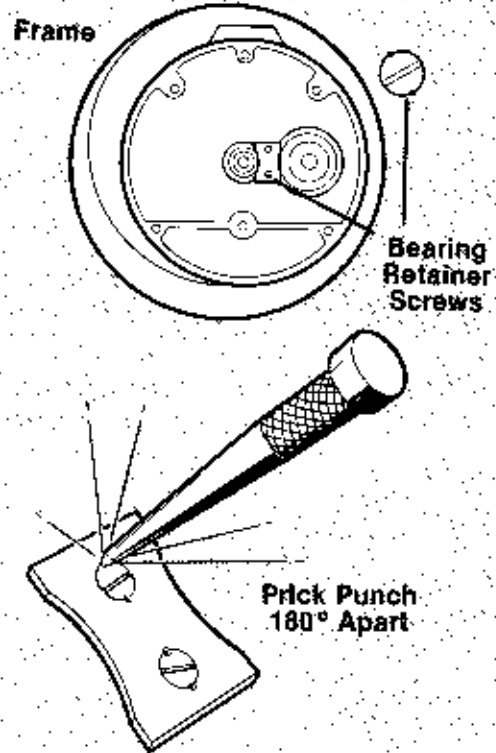

FIGURE 13. Bearing Retainer Screw

Hoist Hanger. The Hoist Hanger and Hoist are not bolted together to form a rigid unit but can move relative to each other.

When installing a new hoist hanger screw (646-234A), tighten the screw firmly and back off one flat (1/6 turn). Then:

3 and 4 ton hoists: Install hoist hanger set screw (646-233B).

5 to 10 ton hoists: Using the hole in the end of the hoist hanger as a guide, drill a 0.250 to 0.256 inch diameter hole through the hoist hanger screw and the other side of the hoist hanger. Complete the assembly by driving the hoist hanger screw pin (646-234D) into hole so that the end of the pin is flush with the end of the hoist hanger (see Figure 14).

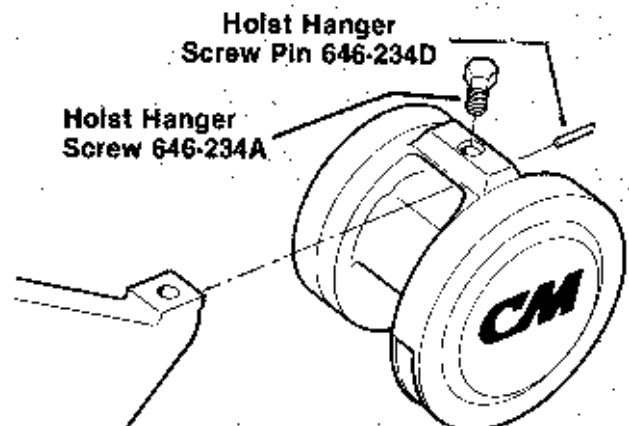

FIGURE 14. Hoist Hanger

Hooks. Both upper and lower hooks must be free to swivel. Those that are held by nuts must be adjusted to provide 1/32" clearance as shown in Figure 15 before the hook nut pin is inserted.

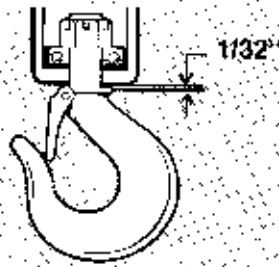



FIGURE 15. Hook Mounting

Lower Hook Thrust Bearings. The 1/4 thru 6 ton lower hook thrust bearings are mounted with the outer shell down (see Figure 15).

Hand Chain. Hand chain must have an odd number of links.

Join the ends with the "hand chain connecting link" (646-45) so that there is no twist in the completed chain loop. The connecting link must be completely closed so that it will seat in the handwheel the same as the welded links.

REEVING

 WARNING
Improper installation (reeving) of the load chain can result in a dropped load.
To Avoid Injury: Reeve and attach the ends of the load in accordance with the following instructions.

1/4-1/2-1 Ton Hoists

Attach approximately 20 inches of wire to the loose end of the load chain. Feed the wire around the liftwheel as shown in Figure 16 until the first link starts over it. The first and third links must stand on edge with the weld away from the liftwheel. After the chain has been started, pull the hand chain or turn the handwheel in the hoisting direction until about 2 feet of load chain has passed over the liftwheel.

If it becomes difficult to pull the hand chain in the hoisting direction, pull it in the lowering direction to release the load chain. Start over. This will prevent the load chain from being jammed between the liftwheel and frame.

Remove the wire and attach the loose end of chain to the hoist using the loose end screw and washer (see Figure 16). The chain must not be twisted between the liftwheel and loose end screw.

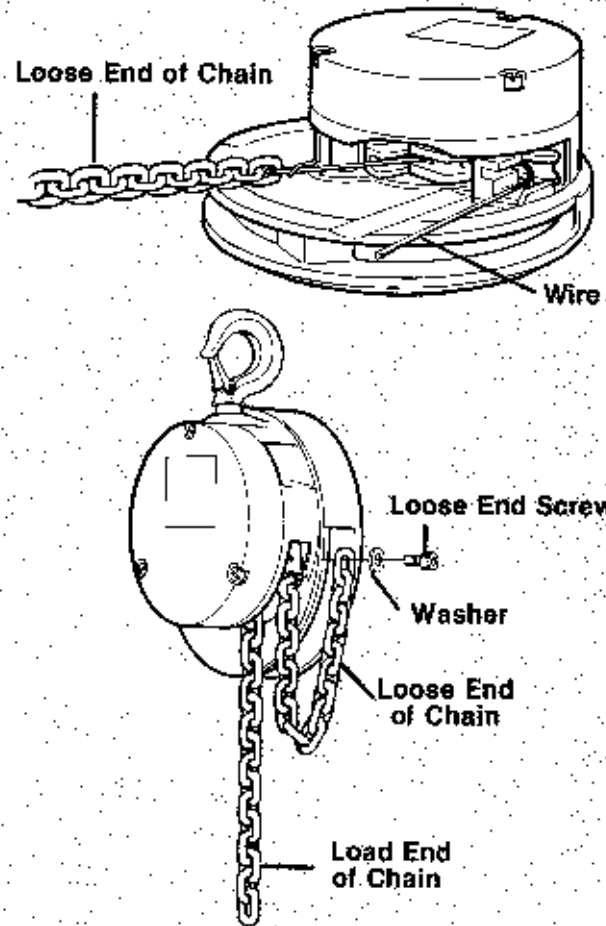

FIGURE 16. Reeving 1/4-1/2-1 Ton Hoists

Mount hoist in a vertical position and check that the lower hook is on the same side of the liftwheel as the upper hook and in line with it.

1 1/2-2 Ton Hoists

Attach approximately 20 inches of wire to the loose end of the load chain. Feed the wire around the liftwheel as shown in Figure 17 until the first link starts over it. The first link must lay flat on the liftwheel. The second link must stand on edge with the weld away from the liftwheel. After the chain has been started, pull the hand chain or turn the handwheel in the hoisting direction until about 2 feet of load chain has passed over the liftwheel.

If it become difficult to pull the hand chain in the hoisting direction, pull it in the lowering direction to release the load chain. Start over. This will prevent the load chain from being jammed between the liftwheel and frame.

Remove the wire and attach the loose end of chain to the hoist using the loose end screw, washer and lock-washer (see Figure 17). The chain must not be twisted between the liftwheel and loose end screw.

Mount hoist in a vertical position and check that the lower hook is on the same side of the liftwheel as the upper hook and in line with it.

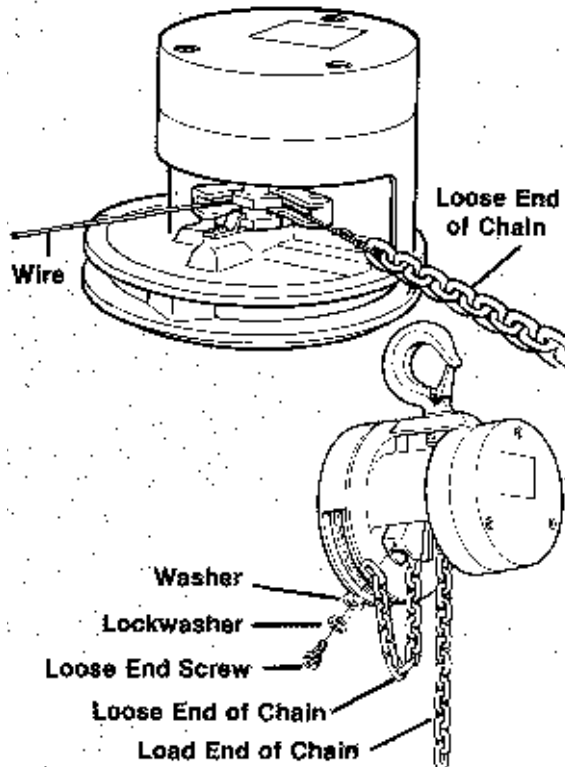

FIGURE 17. Reeving 1½-10 Ton Hoists

3-4 Ton Hoists

Load chain must have an even number of links. Check at each stage of assembly to be sure chain has no twist.

Attach approximately 20 inches of wire to one end of the load chain. Feed the wire around the liftwheel as shown in Figure 17 until the first link starts over it. The first link must lay flat on the liftwheel. The second link must stand on edge with the weld end away from the liftwheel. After the chain has been started, pull the hand chain or turn the handwheel in the hoisting direction until about 2 feet of load chain has passed over the liftwheel.

If it becomes difficult to pull the hand chain in the hoisting direction, pull it in the lowering direction to release the load chain. Start over. This will prevent the load chain from being jammed between the liftwheel and frame. Remove the wire and attach the loose end of chain to the hoist using the loose end screw, washer and lockwasher (see Figure 17).

Mount hoist in a vertical position. Operate in the hoisting direction until the remaining load end of chain is approximately 5 feet long. Reeve load end of chain as shown in Figure 18 in the following sequence.

1. Down around the lower hook block sheave.
2. Up the the hoist hanger.

Secure chain end to hoist hanger with dead end pin. The first link around the hook block sheave must stand on edge (be upstanding).

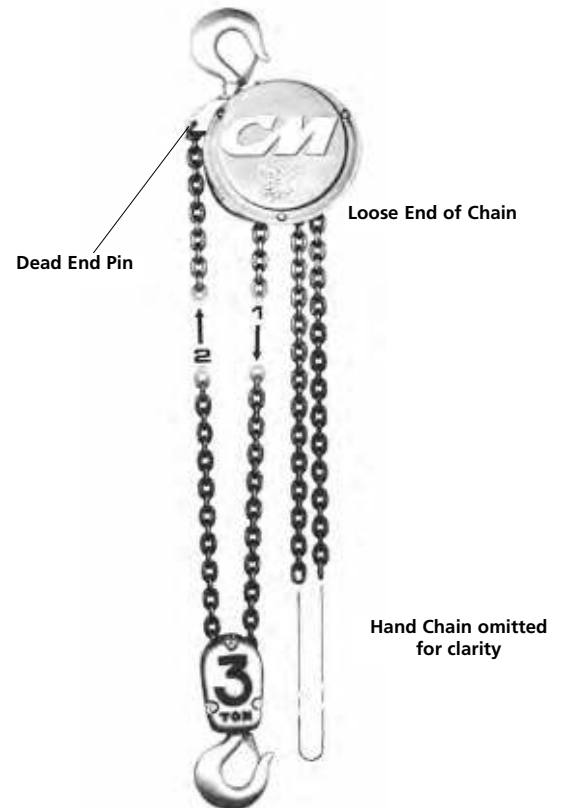

FIGURE 18. Reeving 3-4 Ton Hoists

5-6 Ton Hoists

Load chain must have an even number of links. Check at each stage of assembly to be sure chain has no twist.

Attach approximately 20 inches of wire to one end of the load chain. Feed the wire around the liftwheel as shown in Figure 17 until the first link starts over it. The first link must lay flat on the liftwheel. The second link must stand on edge with the weld away from the liftwheel. After the chain has been started, pull the hand chain or turn the handwheel in the hoisting direction until about 2 feet of load chain has passed over the liftwheel.

If it becomes difficult to pull the hand chain in the hoisting direction, pull it in the lowering direction to release the load chain. Start over. This will prevent the load chain from being jammed between the liftwheel and frame.

Remove the wire and attach the loose end of chain to the hoist using the loose end screw, washer and lockwasher (see Figure 17).

Mount hoist in a vertical position. Operate in the hoisting direction until the remaining load end of chain is approximately 10 feet long. Reeve load end of chain as shown in Figure 19 in the following sequence.

1. Down around the lower hook block sheave.
2. Up around the hoist hanger sheave.
3. Down the lower hook block.

Place end of chain in slot in top of hook block and secure in place with hook block screw, lock-washer and nut. The first link around the hook block and hanger sheaves must stand on edge (be upstanding).

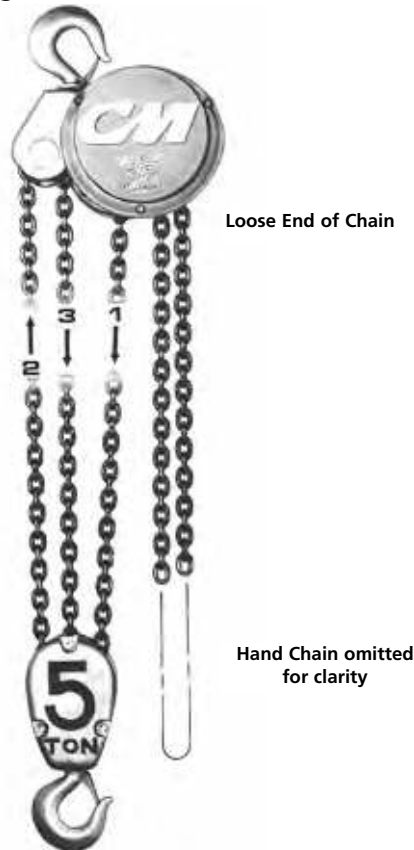

**FIGURE 19. Reeving 5-6 Ton Hoists
8 Ton Hoists**

Load chain must have an even number of links. Check at each stage of assembly to be sure chain has no twist.

Attach approximately 20 inches of wire to one end of the load chain. Feed the wire around the liftwheel as shown in Figure 17 until the first link starts over it. The first link must lay flat on the liftwheel. The second link must stand on edge with the weld away from the liftwheel. After the chain has been started, pull the hand chain or turn the handwheel in the hoisting direction until about 2 feet of load chain has passed over the liftwheel.

If it becomes difficult to pull the hand chain in the hoisting direction, pull it in the lowering direction to release the load chain. Start over. This will prevent the load chain from being jammed between the liftwheel and frame. Remove the wire and attach the loose end of chain to the hoist using the loose end screw, washer and lockwasher (see Figure 17).

Mount hoist in a vertical position. Operate in the hoisting direction until the remaining load end of chain is approximately 15 feet long.

Reeve load end of chain as shown in Figure 20 in the following sequence.

1. Down around the lower hook block sheave.
2. Up around the hoist hanger sheave.
3. Down around the second hook block sheave.
4. Up the the hoist hanger.

Secure end of chain to the chain anchor with the dead end pin. The first link around the hook block sheaves must stand on edge and the first link around the hoist hanger sheave must lay flat.

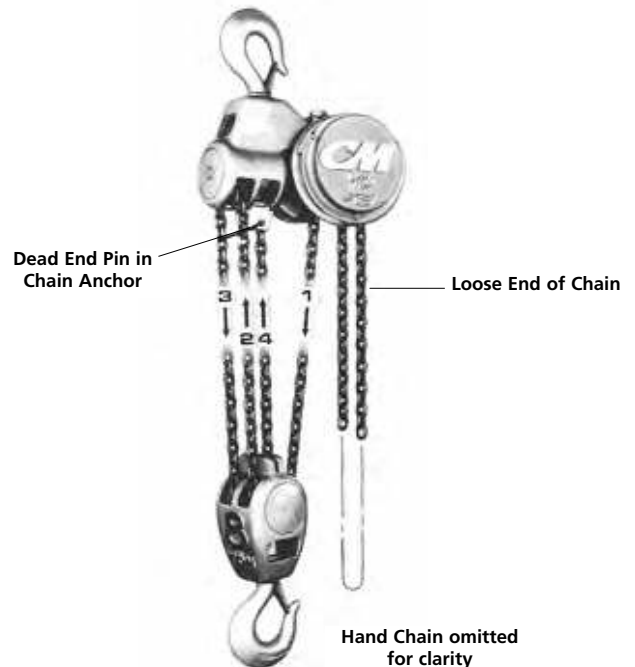

**FIGURE 20. Reeving 8 Ton Hoists
10 Ton Hoists**

Load chain must have an odd number of links. Check at each stage of assembly to be sure chain has no twist.

Attach approximately 20 inches of wire to one end of the load chain. Feed the wire around the liftwheel as shown in Figure 17 until the first link starts over it. The first link must lay flat on the liftwheel. The second link must stand on edge with the weld away from the liftwheel. After the chain has been started, pull the hand chain or turn the handwheel in the hoisting direction until about 2 feet of load chain has passed over the liftwheel.

If it becomes difficult to pull the hand chain in the hoisting direction, pull it in the lowering direction to release the load chain. Start over. This will prevent the load chain from being jammed between the liftwheel and frame.

Remove the wire and attach the loose end of chain to the hoist using the loose end screw, washer and lockwasher (see Figure 17).



FIGURE 21. Reeving 10 Ton Hoists

Mount hoist in a vertical position. Operate in the hoisting direction until the remaining load end of chain is approximately 20 feet long. Reeve load end of chain as shown in Figure 21 in the following sequence.

1. Down around the lower hook block sheave.
2. Up around the hoist hanger sheave.
3. Down around the second hook block sheave.
4. Up around the second hoist hanger sheave.
5. Down to the lower hook block.

Secure end of chain to the hook block with the dead end pin. The first link around the hook block sheaves must lay flat and the first link around the hoist hanger sheaves must stand on edge.

Cutting Chains

Hoistaloy® load chain is hardened for wear resistance and is difficult to cut. However, the following methods are recommended when cutting a length of new chain from stock or cutting off a length of worn chain.

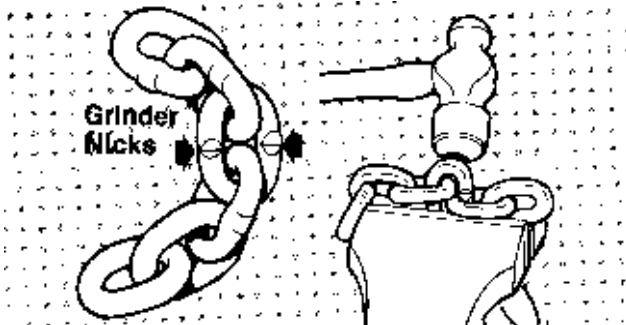

FIGURE 22. Cutting Chain by Nicking

- (1) Use a grinder and nick the link on both sides (see Figure 22), then secure the link in a vise and break off with a hammer.
- (2) Use a 7 inch minimum diameter by 1/8 thick abrasive wheel (of type recommended by wheel supplier) that will clear adjacent links.
- (3) Chain may also be cut using a bolt cutter (see Figure 23) similar to the H.K. Porter No. 0590MTC with special cutter jaws for cutting hardened chain (1 inch long cutting edge).

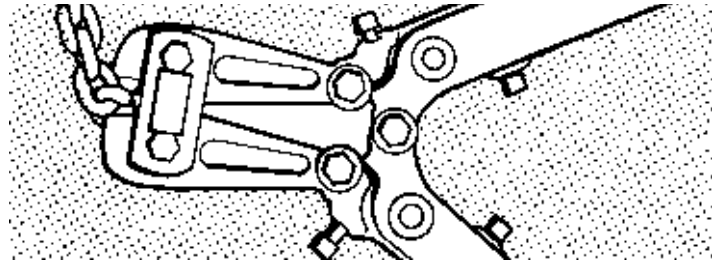



FIGURE 23. Cutting Chain with a Bolt Cutter

 WARNING
Cutting chain can produce flying particle.
<p style="text-align: center;">To Avoid Injury:</p> <ul style="list-style-type: none"> • Wear eye protection. • Provide a shield, such as a heavy rag, over the chain to prevent flying particles.

TESTING

Prior to initial use, all altered or repaired hoists or used hoists that have not been operated for the previous 12 months shall be tested by the user for proper operation.

Test the unit first in the unloaded state and then with a light load of 50 pounds times the number load supporting parts of load chain to be sure it operates properly and the brake holds the load when the hand chain is released; then test with a load of *125% of rated capacity by or under the direction of an appointed person and a written report prepared for record purposes.

After this test, the function of the Load Limiter is to be tested (see Table 3, page 10).

*If load limiter prevents lifting of a load of 125% of rated capacity, reduce load to rated capacity.

NOTE: For additional information on inspection and testing, refer to the current issue of ASME B30.16 "Overhead Hoists" obtainable from ASME Order Department, 22 Law Drive, Box 2300, Fairfield, NJ 07007-2300, U.S.A.

TROUBLESHOOTING

For disassembly and assembly follow instructions on pages 9 through 14. Always test the Cyclone Hoist under load after reassembly of any parts to be sure it operates properly and holds the load when the hand chain is

PROBLEM	CAUSE MAY BE	REMEDY
1 Hoist is hard to operate in either direction.	<p>A) Load chain worn long to gage, thus binding between liftwheel and chain guide.</p> <p>B) Load chain rusty, corroded or clogged up with foreign matter such as cement or mud.</p> <p>C) Load chain damaged.</p> <p>D) Liftwheel clogged with foreign matter or worn excessively, causing binding between the liftwheel and chain guide.</p> <p>E) Hand chain worn long to gage, thus binding between handwheel and cover.</p> <p>F) Handwheel clogged with foreign matter or worn.</p> <p>G) Liftwheel or gear teeth deformed.</p>	<p>A) Check gage of chain (see Page 7). Replace if worn excessively.</p> <p>B) Clean by tumble polishing or using a non-acid or non-caustic type solvent. Lubricate with Lubriplate® Bar and Chain Oil 10-R (Fiske Bros. Refining Co.) or equal lubricant.</p> <p>C) Check chain for gouges, nicks, bent or twisted links. Replace if damaged.</p> <p>D) Clean out pockets. Replace if worn excessively.</p> <p>E) Check gage of chain (see Page 8).</p> <p>F) Clean out pockets. Replace if worn excessively.</p> <p>G) Excessive overload has been applied. Replace damaged parts.</p>
2. Hoist is hard to operate in the lowering direction.	<p>A) Brake parts corroded or coated with foreign matter.</p> <p>B) Chain binding.</p>	<p>A) Disassemble brake and clean thoroughly. (By wiping with a cloth - not by washing in a solvent). Replace washers if gummy, visibly worn or coated with a foreign matter. Keep washers and brake surfaces clean and dry.</p> <p>B) See Items 1A, 1B and 1C.</p>
3. Hoist is hard to operate in the hoisting direction.	<p>A) Chain binding.</p> <p>B) Chain twisted. (3 ton capacity or larger).</p> <p>C) Overload.</p>	<p>A) See Items 1A, 1B and 1C.</p> <p>B) Rereeve chain on 3 and 4 ton unit, if both chains are twisted, capsize hook block through loop in chain until twists are removed. Caution - do not operate unit in hoisting direction with twisted chain or serious damage will result.</p> <p>C) Reduce load or use correct capacity hoist.</p>
4) Hoist will not operate in either direction.	<p>A) Liftwheel gear key or friction hub key missing or sheared.</p> <p>B) Gears jammed.</p>	<p>A) Install or replace key.</p> <p>B) Inspect for foreign matter in gear teeth.</p>
5) Hoist will not operate in the lowering direction.	<p>A) Locked brake due to a suddenly applied load, shock load, or load removed by means other than by operating unit in the lowering direction.</p> <p>B) Chain binding.</p> <p>C) Lower hook all the way out. Load chain fully extended.</p>	<p>A) With hoist under load keep chain taut, pull sharply on hand chain in the lowering direction to loosen brake.</p> <p>B) See Items 1A, 1B and 1C.</p> <p>C) Chain taut between the liftwheel and loose end screw. Operate unit in hoisting direction only.</p>
6. Hoist will not operate in the hoisting direction.	<p>A) Chain binding.</p>	<p>A) See Items 1A, 1B and 1C.</p>
7. Hoist will not hold load in suspension.	<p>A) Lower hook or load side of chain on wrong side of liftwheel.</p> <p>B) Ratchet assembled in reverse.</p> <p>C) Pawl not engaging with ratchet.</p> <p>D) Ratchet teeth or pawl worn or broken.</p> <p>E) Worn brake parts.</p> <p>F) Oily, dirty or corroded brake friction surfaces.</p>	<p>A) Lower hook must be on same side of liftwheel as upper hook.</p> <p>B) Ratchet must be assembled as shown in Figure 10.</p> <p>C) Pawl spring missing or broken. Pawl binding on pawl stud. Replace spring and clean so pawl operates freely and engages properly with ratchet. Do not oil.</p> <p>D) Replace pawl and/or ratchet.</p> <p>E) Replace brake parts which are worn.</p> <p>F) See item 2A.</p>

PARTS LIST

ORDERING INFORMATION

The following information must accompany all correspondence or repair parts orders.

- 1) Hoist capacity.
- 2) Serial Number - this is stamped on the hoist frames as shown below.

For parts orders also specify:

- 1) Quantity desired.
- 2) Key number of part.
- 3) Part name.
- 4) Part number.

When ordering replacement parts, consideration should be given to the need to replace other items: bearings, fasteners, gaskets, etc. Items that may be damaged or lost during disassembly or just unfit for future use because of deterioration from age or service.

! WARNING

Using "Commercial" or other manufacturer's parts to repair the Cyclone Hand and Low Headroom Trolley Hoists may cause load loss.

To Avoid Injury:

Order all replacement parts from CM. Parts may look alike but often CM parts are made of specific materials or processed to achieve specific properties.

Parts should be ordered from CM's Master Parts Depots conveniently located throughout the United States. Refer to page i of this manual to locate the Hoist Parts Depot nearest you.

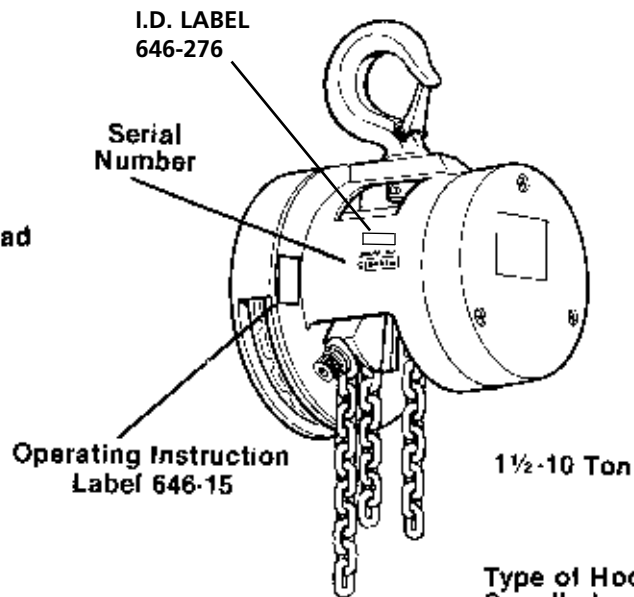
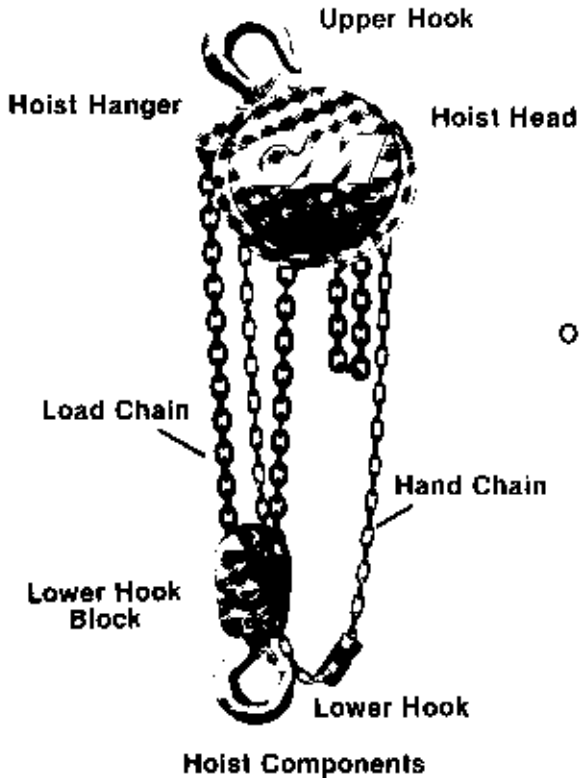
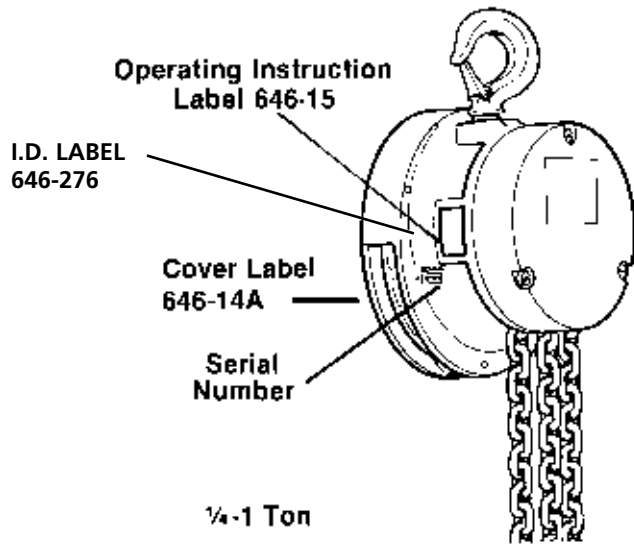

Type of Hooks Supplied on Hoists:



Latchlok Type Hook

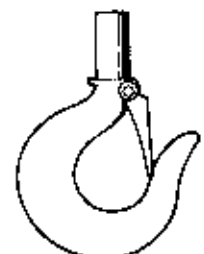

Latch Type Hook

Figure 24. Ordering Information

Key No.	No. Req'd	Part Name	Capacity - Ton				
			¼ & ½	1	1½ & 2	5 & 6	8 & 10
			Part Number				
646-1	1	Frame with Upper Hook (includes Items 646-1A thru 646-1F and 646-15)-Not Shown	C701	C702	--		
646-1A	1	Frame	45612C		--		
646-1B	1	Upper Hook (Includes Latch) - Latch Type	45601	45602	--		
646-1B	1	Upper Hook - Latchlok Type	1020	1022	--		
646-1C	2	Upper Hook Washer	45930		--		
646-1D	1	Upper Hook Collar	41350	27359	--		
646-1E	1	Upper Hook Collar Pin	45940	45941	--		
646-1F	1	Upper Hook Sleeve	45930	--	--		
646-2A	1	Load Chain Guide	45047	45048	--		
646-2B	2	Load Chain Guide Screw	945807		--		
646-2C	2	Load Chain Guide Screw L.W.	945851		--		
646-3A	1	Stripper	45043		--		
646-3B	1	Stripper Screw	983745		--		
646-3C	1	Stripper Screw L.W.	940830		--		
646-4	1	Handwheel Shaft and Pinion with Bearings (Items 646-4A thru 646-4D-Not Shown)	C703	C704	--		
646-4A	1	Handwheel Shaft and Pinion	45353	45354	--		
646-4B	1	Pinion Shaft Bearing (Handwheel End)	88437		--		
646-4C	1	Pinion Shaft Bearing (Gear End)	88444		--		
646-4D	1	Handwheel Shaft Snap Ring	45873		--		
646-5	1	Pawl			45038		
646-5A	1	Pawl Bushing			45735		
646-6	1	Pawl Retaining Washer			45910		
646-7	1	Pawl Stud Snap Ring			45767		
646-8	1	Pawl Spring			45730		
646-9	1	Brake Assembly (Items 646-9A, 646-9B and 646-9CD)-Not Shown			C705		
646-9A	1	Friction Hub			45007		
646-9B	2	Friction Washer	45741 For Units With Load Limiters, 45831 For Units Without Load Limiters				
646-9CD	1	Ratchet with Bushing			45614		
646-9D	1	Ratchet Bushing			45718		
646-10	1	Non-Load Limiter Handwheel			46699		
646-11	1	Handwheel Shaft Nut Washer			45915		
646-12	1	Handwheel Shaft Nut			931717		
646-13	1	Friction Hub Key			45770		
646-14	1	Handwheel Cover			46005		
646-14A	1	Cover Label	946753		--		
646-15	1	Operating Instruction Label (See page 16)-Not Shown			946900		
646-15A	3	Handwheel Cover Screw			982698		
646-16	1	Liftwheel with Bearings (Items 646-16A thru 646-16D)-Not Shown	C706	C707	--		
646-16A	1	Liftwheel	45364	45365	--		
646-16B	1	Liftwheel Bearing (Handwheel End)	88489		--		
646-16C	1	Liftwheel Bearing (Gear End)	88429		--		
646-16D	1	Liftwheel Snap Ring	45871		--		
646-17A	1	Frame Bearing Retainer	45750		--		
646-17B	2	Frame Bearing Retainer Screw	987716		--		
646-18	1	Liftwheel Gear	45061	45060	--		
646-19	1	Liftwheel Gear Key	989101		--		
646-20	1	Liftwheel Gear Snap Ring	68703		--		
646-24	1	Gear Cover with Capacity Insert	C708 for ¼ Ton, C721 for ½ Ton and C722 for 1 Ton				
646-24A	1	Capacity Insert	46705 (¼ Ton)		--		
			46706 (½ Ton)		--		
			46707 (1 Ton)		--		
646-24B	2	Capacity Insert Pin			988271		
646-24C	3	Gear Cover Screw	987322		--		
646-24D	1	Gear Cover Gasket	45745		--		
646-25A	1	Loose End Screw	946801		--		
646-25B	1	Loose End Screw Washer	954807		--		
646-29	1	Lower Hook and Block Assembly-Latch Type Hook	28683	45668	--		
646-29A	1	Lower Hook with Latch-Latch Type Hook	28686		35611		
646-29A	1	Lower Hook-Latchlok Type Hook	1051		--		
646-29B	1	Hook Block Body	45401		--		
646-29D	1	Lower Hook Washer	945921		--		
646-29E	1	Lower Hook Thrust Bearing	88485		--		
646-29F	1	Lower Hook Nut	982526		--		
646-29G	1	Lower Hook Nut Pin	983772		--		
646-29H	1	Lower Hook Chain Block	28007	45016	--		
646-29J	1	Hook Block Pin	45943		--		
646-30	1	Load Chain (Specify Lift or Length Req'd)	85839	85841	--		
646-31	1	Hand Chain (Specify Lift or Length Req'd)			85808		
646-32	1	Warning Tube			946735		
646-38	2	Latch Kit	45661	45662	--		
646-45	1	Hand Chain Connecting Link			945490		
646-101	1	Frame with Upper Hook (includes Items 646-101A thru 646-101E and 646-15)-Not Shown			C730		--
646-101A	1	Frame			45613C		

CYCLONE HAND HOIST PARTS LIST

Key No.	No. Req'd	Part Name	Capacity - Ton					
			1/4 & 1/2	1	1-1/2 & 2	3 & 4	5 & 6	8 & 10
			Part Number					
646-101B	1	Upper Hook (Includes Latch) Latch Type	--		45604		--	
646-101B	1	Upper Hook-Latchlok Type	--		1023		--	
646-101C	2	Upper Hook Washer	--		45918		--	
646-101D	1	Upper Hook Collar	--		35478		--	
646-101E	1	Upper Hook Collar Pin	--		45946		--	
646-102A	1	Load Chain Guide	--				45049	
646-102B	3	Load Chain Guide Screw	--				945815	
646-102C	3	Load Chain Guide Screw L.W.	--				45852	
646-103A	1	Stripper	--				45420	
646-103B	2	Stripper Screw	--				982709	
646-104	1	Handwheel Shaft and Pinion with Bearings (Items 646-104A, 646-104B and 646-104C) - Not Shown	--				C710 For 1-1/2 & 3 Ton, C711 For 2, 4, 5, 6, 8 & 10 Ton	
646-104A	1	Handwheel Shaft and Pinion	--		45355 for 1-1/2 & 3 Ton,		45356 for 2, 4, 5, 6, 8 & 10 Ton	
646-104B	1	Handwheel Shaft Bearing (Handwheel End)	--				88437	
646-104C	1	Handwheel Shaft Bearing (Pinion End)	--				83671	
646-116	1	Liftwheel with Bearings (Items 646-116A thru 646-116E) - Not Shown	--				C712	
646-116A	1	Liftwheel	--				45057	
646-116B	1	Liftwheel Bearing (Handwheel End)	--				88445	
646-116C	1	Liftwheel Bearing (Gear End)	--				83669	
646-116D	1	Liftwheel Snap Ring	--				45766	
646-116E	1	Liftwheel Bearing Retaining Ring (Gear End)	--				46800	
646-118	1	Liftwheel Gear	--				45008	
646-119	2	Liftwheel Dowel Pin	--				45771	
646-121	1	Intermediate Gear and Pinion with Bearings (Items 646-121A, 646-121B and 646-121C) - Not Shown			C713 for 1 1/2 & 3 Ton, C714 for 2, 4, 5, 6, 8 & 10 Ton			
646-121A	1	Intermediate Gear & Pinion	--		45014 for 1-1/2 & 3 Ton (7 & 45 Teeth)		45015 for 2, 4, 5, 6, 8 & 10 Ton (7 & 47 Teeth)	
646-121B	1	Intermediate Gear Bearing (Pinion End)	--				83682	
646-121C	1	Intermediate Gear Bearing (Cover End)	--				88437	
646-122	2	Gear Cover Dowel	--				46730	
646-124	1	Gear Cover with Capacity Insert			C715 for 1-1/2 Ton, C723 for 2 Ton, C724 for 3 Ton, C725 for 4 Ton, C726 for 5 Ton, C727 for 6 Ton, C728 for 8 Ton & C729 for 10 Ton			
646-124A	1	Capacity Insert			46708 (1-1/2 Ton), 46709 (2 Ton), 46710 (3 Ton), 46711 (4 Ton), 46712 (5 Ton), 46713 (6 Ton), 46714 (8 Ton), 46715 (10 Ton)			
646-124B	2	Capacity Insert Pin	--				988271	
646-124C	3	Gear Cover Screw	--				983732	
646-124D	1	Gear Cover Gasket	--				46704	
646-125A	1	Loose End Screw	--				945815	
646-125B	1	Loose End Screw L.W.	--				945852	
646-125C	1	Loose End Screw Washer	--				954806	
646-129	1	Lower Hook and Block Assembly-Latch Type Hook	--		45669		--	
646-129A	1	Lower Hook with Latch-Latch Type Hook	--		45603		--	
646-129A	1	Lower Hook-Latchlok Type Hook	--		1024		--	
646-129B	1	Hook Block Body	--		45399		--	
646-129E	1	Lower Hook Thrust Bearing	--		88505		--	
646-129F	1	Lower Hook Nut	--		45382		--	
646-129G	1	Lower Hook Nut Pin	--		983779		--	
646-129H	1	Lower Hook Chain Block	--		45017		--	
646-129J	1	Hook Block Pin	--		45948		--	
646-130	1	Load Chain (Specify Lift or Length Req'd)	--				85864	
646-131	1	Hand Chain (Specify Lift or Length Req'd)			85808			
646-132	1	Load Limiter Complete			44602 for 1/4 Ton, 44601 for 1/2 Ton, 44600 for 1 thru 10 Ton			
646-133	1	Handwheel Sub-Assembly			45675			
646-134	1	Load Limiter Hub			45012			
646-135	2	Friction Washer			45886			
646-136	1	Steel Washer			45032			
646-137	1	Spring Washer			45888			
646-138	1	Lockwasher			45033			
646-139	1	Nut			45737			
646-144	2	Latch Kit	--		45663		--	
646-201B	1	Upper Hook (Includes Latch)-Latch Type	--			45607	45606 (5T.) 40607 (6T.)	45609
646-201B	1	Upper Hook-Latchlok Type	--			1025	1027	1028
646-201C	2	Upper Hook Washer	--			40736		988005
646-201E	1	Upper Hook Nut Pin	--			983787		983788
646-201F	1	Upper Hook Nut	--			940834		945836
646-206	2	Latch Kit	--			45664	45664 (5T.) 45665 (6T.)	*45697
646-229	1	Lower Hook Block Assembly - Not Shown			45670 for 3 Ton, 45615 for 4 Ton, 45616 for 5 Ton, 45617 for 6 Ton, 45619 for 8 & 10Ton			
646-229A	1	Lower Hook (Includes Latch)-Latch Type	--			45605	45606 (5T.) 40607 (6T.)	45609
646-229A	1	Lower Hook-Latchlok Type	--			1026	1027	1028

*NOTE: 8 ton units before serial no. S-A006GT used latch kit part number 45696.

Key No.	No. Req'd	Part Name	Capacity - Ton						
			1/4 & 1/2	1	1-1/2 & 2	3 & 4	5 & 6	8 & 10	
			Part Number						
646-229B	1	Lower Hook Sleeve	--	--	--	45394	45393	45410	
646-229G	1	Lower Hook Pin	--	--	--	983787		983788	
646-229K	1	Lower Hook Nut	--	--	--	940834		945836	
646-229L	1	Lower Hook Thrust Bearing	--	--	--	88507		88511	
646-233A	1	Hoist Hanger (Also order 646-234A and 646-234B or 646-234D as applicable)	--	--	--	45090	45091	45094	
646-233B	1	Hoist Hanger Set Screw	--	--	--	986304		--	
646-234A	1	Hoist Hanger Screw (Also order 646-234B or 646-234D as applicable)	--	--	--	987223		987179	
646-234C	1	Hoist Hanger Screw Washer	--	--	--	945916		--	
646-234D	1	Hoist Hanger Screw Pin	--	--	--	983789		--	
646-235	1	Hoist Hanger Screw Sleeve	--	--	--	45391		--	
646-236	1	Hoist Hanger Sheave Cap (Tapped)	--	--	--			45123	
646-237	1	Hoist Hanger Sheave Cap (Drilled)	--	--	--			45124	
646-238	1	Hoist Hanger Chain Anchor	--	--	--			45134 (8T.)	
646-239	1 or 2	Hoist Hanger Sheave	--	--	--	45085		45106	
646-241	1 or 2	Hoist Hanger Bearing	--	--	--			88542	
646-242	2	Hoist Hanger Sheave Bearing	--	--	--	83670		--	
646-243	1	Hoist Hanger Snap Ring	--	--	--	45765		--	
646-244	2	Hoist Hanger Bearing Retainer	--	--	--	45151		--	
646-245	2	Hoist Hanger Sheave Shaft	--	--	--			45425	
646-246A	1	Hoist Hanger Sheave Shaft Bolt	--	--	--			89411	
646-246B	1	Hoist Hanger Sheave Shaft Bolt L.W.	--	--	--			987919	
646-247	2	Lower Hook Block (Also order Capacity Insert 646-275 For 5 & 6 Ton)	--	--	--	45107 (3T.) 45096 (4T.)	45101	--	
646-248	1	Lower Hook Block Body (Also order Capacity Insert 646-275)	--	--	--			45104	
646-249A	3	Lower Hook Block Screw	--	--	--	945796		45812	
646-249B	3	Hook Block Screw Nut	--	--	--	945820		945822	
646-249C	3	Hook Block Screw L.W.	--	--	--	945851		945853	
646-250	1 or 2	Hook Block Sheave	--	--	--	45086		45106	
646-252	1 or 2	Hook Block Sheave Bearing	--	--	--			88542	
646-253	2	Hook Block Sheave Bearing	--	--	--	83670		--	
646-254	1 or 2	Hook Block Sheave Shaft	--	--	--			45425	
646-256A	1	Hook Block Sheave Shaft Bolt	--	--	--			89411	
646-256B	1	Hook Block Sheave Shaft Bolt L.W.	--	--	--			987919	
646-257	1	Hook Block Sheave Cap (Tapped)	--	--	--			45123	
646-258	1	Hook Block Sheave Cap (Drilled)	--	--	--			45124	
646-259	1	Dead End Pin	--	--	--	45945		45944	
646-260	2	Reeving Caution Plate	--	--	--	45757		--	
646-275	1	Capacity Insert	46712 for 5 Ton, 46713 for 6 Ton, 45837 for 8 Ton & 45838 for 10 Ton						
646-276	1	I.D. Label	46203		46202				

Part Numbers for packaged lubricants used in Cyclone Hand and Low Headroom Trolley Hoists

Lubricant Usage	Type of Lubricant	Part Numbers and Packaged Quantities of Lubricants
Gears	Grease	28610 (1#can) 28632 (4#can)
Handwheel Threads	Spray	46698 (16 oz.)
Chain	Oil	28608 (1 pt. can) 28619 (1 gal. can)
Trackwheel Bearings	Grease	28610 (1#can) 28632 (4#can)
Trackwheel Gears	*Heavy Cup Grease	--
Handwheel Shaft	*Light Machine Oil	--

*These are not furnished by CM in Packaged Quantities. When ordering lubricants, specify the type of lubricant, part number and packaged quantity required.

- Touch-up Paints for Cyclone Hand and Low Headroom Trolley Hoists:
1. Hoist. Order *(1) case (12-12 oz. Aerosol Cans) of Orange Touch-up paint Part Number 84190.
 2. Trolley. Order *(1) case (12-12 oz. Aerosol Cans) of Black Touch-up paint Part Number 84189.

*Touch-up paints are only available in case quantities.

NOTE: When painting hoists or trolleys, also order warning labels, identification labels, etc. that may be coated during painting.

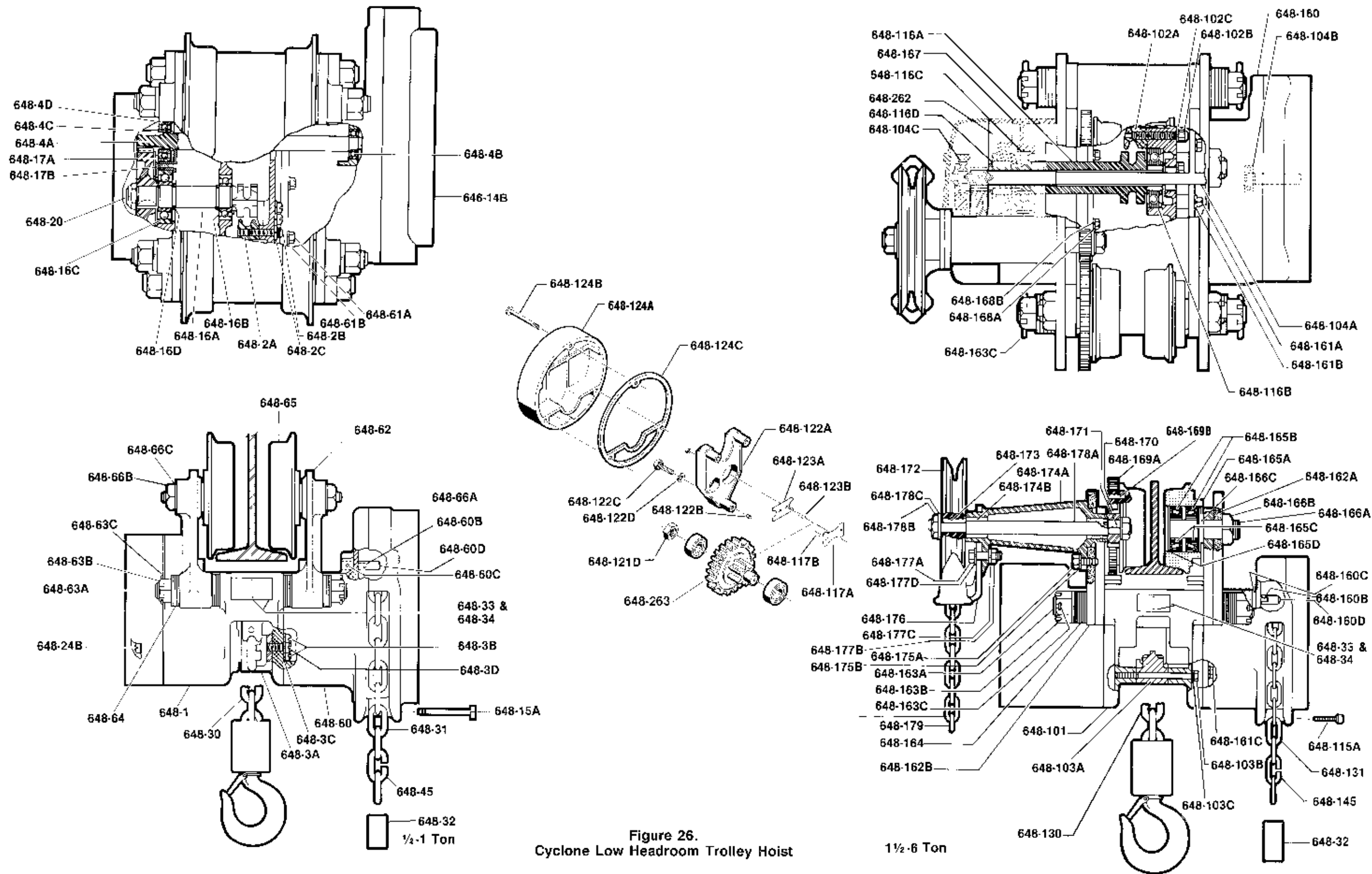
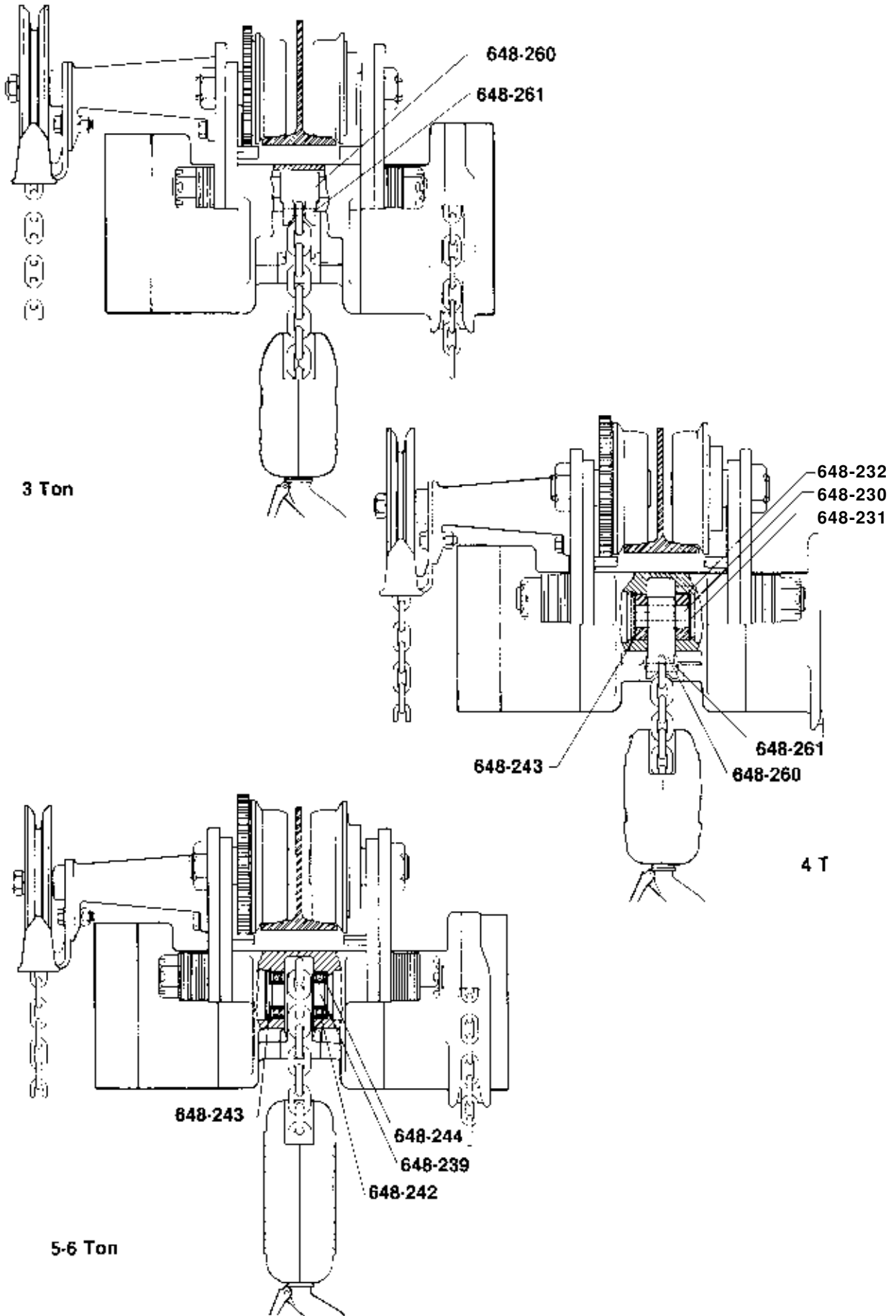

Figure 26. Cyclone Low Headroom Trolley Hoist



Key No.	No. Req'd.	Part Name	Capacity - Ton		
			1/2 & 1	1-1/2, 2 & 3	4, 5 & 6
			Part Number		
648-1	1	Main Frame	48001C		--
648-2A	1	Load Chain Guide	45047 (1/2 T.) 45048 (1T.)		--
648-2B	2	Load Chain Guide Screw	982368		--
648-2C	2	Load Chain Guide Screw L.W.	945851		--
648-3A	1	Stripper	45043		--
648-3B	2	Stripper Screw-Long	982709		--
648-3C	3	Stripper Screw L.W.	Order 648-3B & 648-3D		--
648-3D	1	Stripper Screw-Short	987315		--
648-4A	1	Handwheel Shaft & Pinion	45357 (1/2 T.) 45358 (1 T.)		--
648-4B	1	Handwheel Shaft Bearing (Handwheel End)	88437		--
648-4C	1	Handwheel Shaft Bearing (Gear End)	88444		--
648-4D	1	Handwheel Shaft Snap Ring	45873		--
648-14B	1	Cover Label		946754	
648-15A	3	Handwheel Cover Screw	982698		--
648-16A	1	Liftwheel	48362 (1/2 T.) 48368 (1 T.)		--
648-16B	1	Liftwheel Bearing (Handwheel End)	88429		--
648-16C	1	Liftwheel Bearing (Gear End)	83674		--
648-16D	2	Liftwheel Snap Ring	48704		--
648-17A	1	Frame Bearing Retainer	48702		--
648-17B	2	Frame Bearing Retainer Screws	987716		--
648-20	1	Liftwheel Shaft Nut	945841		--
648-24B	3	Gear Cover Screw	987322		--
648-30	1	Load Chain (Specify Lift or Length Req'd.)	85839 (1/2 T.) 85841 (1 T.)		--
648-31	1	Hand Chain (Specify Lift or Length Req'd.)	85808		--
648-32	1	Warning Tube		946735	
648-33	1	I.D. Plate		45982	
648-34	2	Drive Screw		988271	
648-45	1	Hand Chain Connecting Link	945490		--
648-60	1	Front Frame with Pawl Stud and Pawl Spring Pin	48611C		--
648-60B	1	Pawl Spring Pin	983531		--
648-60C	1	Pawl Stud Pin	983494		--
648-60D	1	Pawl Stud	48376		--
648-61A	4	Front Frame Screw	987019		--
648-61B	4	Front Frame Screw L.W.	945851		--
648-62	2	Trolley Frame	*48005		--
648-63A	2	Suspension Bolt	*48371		--
648-63B	4	Suspension Bolt Nut	948803		--
648-63C	4	Suspension Bolt Cotter Pin	988343		--
648-64	-	Spacer Washer (Specify Quantity)	948700		--
648-65	4	Trackwheel	*50762		--
648-66A	4	Trackwheel Stud	*48300		--
648-66B	4	Trackwheel Stud Nut	*948804		--
648-66C	4	Trackwheel Stud Nut L.W.	*987924		--
648-101	1	Main Frame	--	**48010C for 1-1/2 & 2 Ton, 48010C for 3 Ton, 48013C for 4, 5 & 6 Ton	
648-102A	1	Load Chain Guide	--	45049	
648-102B	3	Load Chain Guide Screw	--	948805	
648-102C	3	Load Chain Guide Screw L.W.	--	45852	
648-103A	1	Stripper	--	48043	
648-103B	1	Stripper Screw	--	87055	
648-103C	1	Stripper Screw L.W.	--	987919	
648-104A	1	Handwheel Shaft and Pinion	--	45360 (10 Teeth, 18-7/64 Long) for 1-1/2 & 3 Ton, 45359 (8 Teeth, 18-7/64 Long) for 2 Ton and 45361 (8 Teeth, 20-47/64 Long) for 4, 5 & 6 Ton.	
648-104B	1	Handwheel Shaft Bearing (Handwheel End)	--	88437	
648-104C	1	Handwheel Shaft Bearing (Gear End)	--	83671	
648-112	2	Handwheel Shaft Nut	--	931717	
648-115A	3	Handwheel Cover Screw	--	982698	
648-116A	1	Liftwheel	--	48369	48370
648-116B	1	Liftwheel Bearing (Handwheel End)	--	83678	
648-116C	1	Liftwheel Bearing (Gear End)	--	83669	
648-116D	1	Liftwheel Snap Ring	--	45766	
648-117A	1	Frame Bearing Retainer	--	45751	
648-117B	2	Frame Bearing Retainer Screw	--	987716	
648-121D	1	Intermediate Gear and Pinion Nut	--	931717	
648-122A	1	Spider	--	45035	
648-122B	2	Spider Dowel	--	45430	
648-122C	3	Spider Attaching Screw	--	982689	
648-122D	3	Spider Attaching Screw L.W.	--	940830	

*Part numbers listed are for trolleys that operate on 6" thru 12" S-beams. If trolley operates on 4" or 5" S-beam, part numbers are as follows: 48006 for 648-62 trolley frame, 48373 for 648-63A suspension bolt, 54732 for 648-65 trackwheel, 54731 for 648-66A trackwheel stud, 982521 for 648-66B trackwheel stud nut and 987921 for 648-66C trackwheel stud nut lockwasher.

**Part number listed is for trolley that operates on 7" thru 15" S-beams. If trolley operates on 6" S-beam, part number is 48032C (1-1/2 & 2 Ton).

Key No.	No. Req'd.	Part Name	Capacity - Tons		
			1/2 & 1	1-1/2, 2 & 3	4, 5 & 6
			Part Number		
648-123A	1	Spider Bearing Retainer	--	45752	
648-123B	2	Spider Bearing Retainer Screw	--	987716	
648-124A	1	Gear Cover	--	45717C	
648-124B	3	Gear Cover Screw	--	983732	
648-124C	1	Gear Cover Gasket	--	45746	
648-130	1	Load Chain (Specify Lift or Length Req'd.)	--	85864	
648-131	1	Hoist Hand Chain (Specify Lift or Length Req'd.)	--	85808	
648-145	1	Hand Chain Connecting Link	--	945490	
648-160	1	Front Frame with Pawl Stud and Pawl Spring Pin	--	48612C	
648-160B	1	Pawl Spring Pin	--	983531	
648-160C	1	Pawl Stud Pin	--	983535	
648-160D	1	Pawl Stud	--	48376	
648-161A	4	Front Frame Screw	--	987020	
648-161B	5	Front Frame Screw L.W.	--	945851	
648-161C	1	Front Frame and Stripper Screw	--	948807	987034
648-162A	1	Trolley Frame (Specify if for Plain or Geared)	--	48668	48670
648-162B	1	Trolley Frame (Specify if for Plain or Geared)	--	48667 for 1-1/2, 2 & 3 Ton Plain Trolley 46664 for 1-1/2, 2 & 3 Ton Geared Trolley 48669 for 4, 5 & 6 Ton Plain Trolley 46665 for 4, 5 & 6 Ton Geared Trolley	
648-163A	2	Suspension Bolt	--	58503 (1" Dia. x 12-1/4" Long) for 1-1/2, 2 and 3 Ton. 48372 (1-1/4 Dia. x 15" Long) for 4, 5 & 6 Ton	
648-163B	4	Suspension Bolt Nut	--	958818	945835
648-163C	4	Suspension Bolt Cotter Pin	--	988368	988381
648-164	--	Spacer Washer (Specify Quantity)	--	958726	948701
648-165A	4	Trackwheel	--	58162	58163
648-165B	8	Trackwheel Bearing Cup	--	88521	88556
648-165C	8	Trackwheel Bearing Cone	--	88525	88545
648-165D	8	Trackwheel Bearing Seal Washer	--	68918	68917
648-166A	4	Trackwheel Stud	--	58459	58540
648-166B	4	Trackwheel Stud Nut	--	982613	988192
648-166C	4	Trackwheel Stud Collar	--	58484	58492
648-167	1	Gear Housing	--	48015C	
648-168A	5	Gear Housing Screw	--	948806	948807
648-168B	5	Gear Housing Screw L.W.	--	945851	
648-169A	2	Trackwheel Gear	--	58548	58549
648-169B	4	Trackwheel Gear Pin	--	983503	
648-170	1	Trackwheel Pinion	--	46385	
648-171	1	Trackwheel Pinion Key	--	85446	
648-172	1	Trolley Handwheel	--	33143	
648-173	1	Trolley Handwheel Key	--	59967	
648-174A	1	Handwheel Bracket with Bushings	--	59616	
648-174B	2	Handwheel Bracket Bushing	--	58727	
648-175A	3	Handwheel Bracket Screw	--	987061	
648-175B	3	Handwheel Bracket Screw L.W.	--	945853	
648-176	1	Trolley Hand Chain Guide	--	58152	
648-177A	1	Trolley Hand Chain Guide Screw	--	987065	
648-177B	1	Trolley Hand Chain Guide Screw Nut	--	945822	
648-177C	1	Trolley Hand Chain Guide Screw L.W.	--	945853	
648-177D	1	Trolley Hand Chain Guide Screw Washer	--	986224	
648-178A	1	Trolley Handwheel Shaft	--	58504	
648-178B	2	Trolley Handwheel Shaft Nut	--	988095	
648-178C	2	Trolley Handwheel Shaft L.W.	--	986270	
648-179	1	Trolley Hand Chain (Specify Lift or Length Req'd)	--	85808	
648-180	1	Hand Chain Connecting Link	--	945490	
648-230	1	Hanger Chain Anchor Pin (4 Ton)	--	--	45425
648-231	2	Hanger Chain Anchor Pin Retainer (4 Ton)	--	--	48024
648-232	2	Hanger Chain Anchor Pin Block (4 Ton)	--	--	48393
648-239	1	Upper Sheave (5 & 6 Ton)	--	--	45085
648-242	2	Upper Sheave Bearing (5 & 6 Ton)	--	--	83670
648-243	1	Hanger Snap Ring (4 Ton)	--	--	45765
648-243	1	Upper Sheave Bearing Snap Ring (5 & 6 Ton)	--	--	45765
648-244	2	Upper Sheave Bearing Retainer (5 & 6 Ton)	--	--	45151
648-260	1	Hanger Chain Anchor	--	48019 (3 Ton)	48021 (4 Ton)
648-261	1	Dead End Pin (3 & 4 Ton)	--	45945 (3 Ton)	
648-262	1	Liftwheel Gear	--	45062	
648-263	1	Intermediate Gear and Pinion	--	45080 for 1-1/2 & 3 Ton, 45081 for 2, 4, 5 & 6 Ton	